

# LM4947 Boomer® Audio Power Amplifier Series

## Mono Class D and Stereo Audio Sub-System with OCL Headphone Amplifier and National 3D

### General Description

The LM4947 is an audio subsystem capable of efficiently delivering 500mW (Class D operation) of continuous average power into a mono 8 $\Omega$  bridged-tied load (BTL) with 1% THD+N, 37mW (Class AB operation) power channel of continuous average power into stereo 32 $\Omega$  single-ended (SE) loads with 1% THD+N, or an output capacitor-less (OCL) configuration with identical specification as the SE configuration, from a 3.3V power supply.

The LM4947 has six input channels: one pair for a two-channel stereo signal, the second pair for a secondary two-channel stereo input, and the third pair for a differential single-channel mono input. Additionally, the two sets of stereo inputs may be configured as a single stereo differential input (differential left and differential right). The LM4947 features a 32-step digital volume control and eight distinct output modes. The digital volume control, 3D enhancement, and output modes are programmed through a two-wire I<sup>2</sup>C compatible interface that allows flexibility in routing and mixing audio channels.

The RF suppression circuitry in the LM4947 makes it well-suited for GSM mobile phones and other portable applications in which strong RF signals generated by an antenna (and long output traces) may couple audibly into the amplifier.

The LM4947 is designed for cellular phones, PDAs, and other portable handheld applications. It delivers high quality output power from a surface-mount package and requires only eight external components in the OCL mode (two additional components in SE mode).

### Key Specifications

■ THD+N at 1kHz, 500mW into 8 $\Omega$ BTL (3.3V)	1.0% (typ)
■ THD+N at 1kHz, 37mW into 32 $\Omega$ SE (3.3V)	1.0% (typ)
■ Single Supply Operation ( $V_{DD}$ )	2.7 to 5.5V
■ I <sup>2</sup> C Single Supply Operation	2.2 to 5.5V

### Features

- I<sup>2</sup>C Control Interface
- I<sup>2</sup>C programmable National 3D Audio
- I<sup>2</sup>C controlled 32 step digital volume control (-59.5dB to +18dB)
- Three independent volume channels (Left, Right, Mono)
- Eight distinct output modes
- Small, 25-bump micro SMD packaging
- "Click and Pop" suppression circuitry
- Thermal shutdown protection
- Low shutdown current (0.1 $\mu$ A, typ)
- RF suppression
- Differential mono and stereo inputs
- Stereo input mux

### Applications

- Mobile Phones
- PDAs

# Typical Application

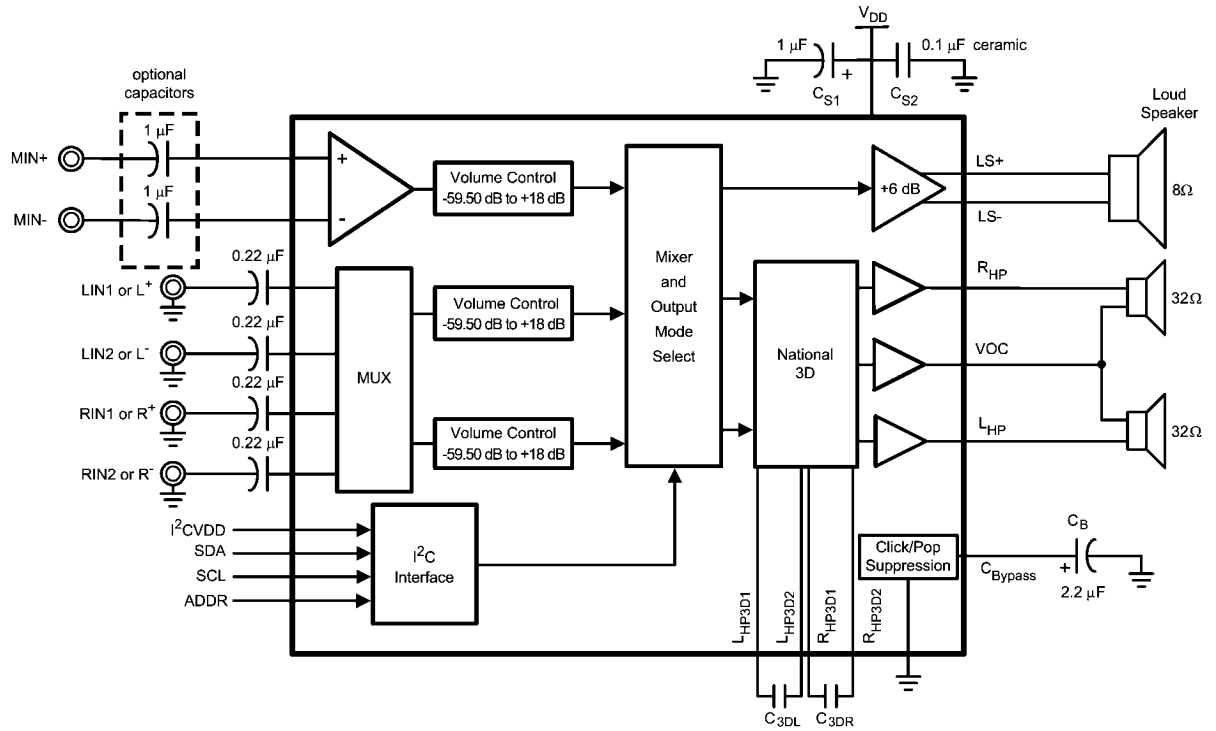

201735d3

FIGURE 1. Typical Audio Amplifier Application Circuit-Output Capacitor-less

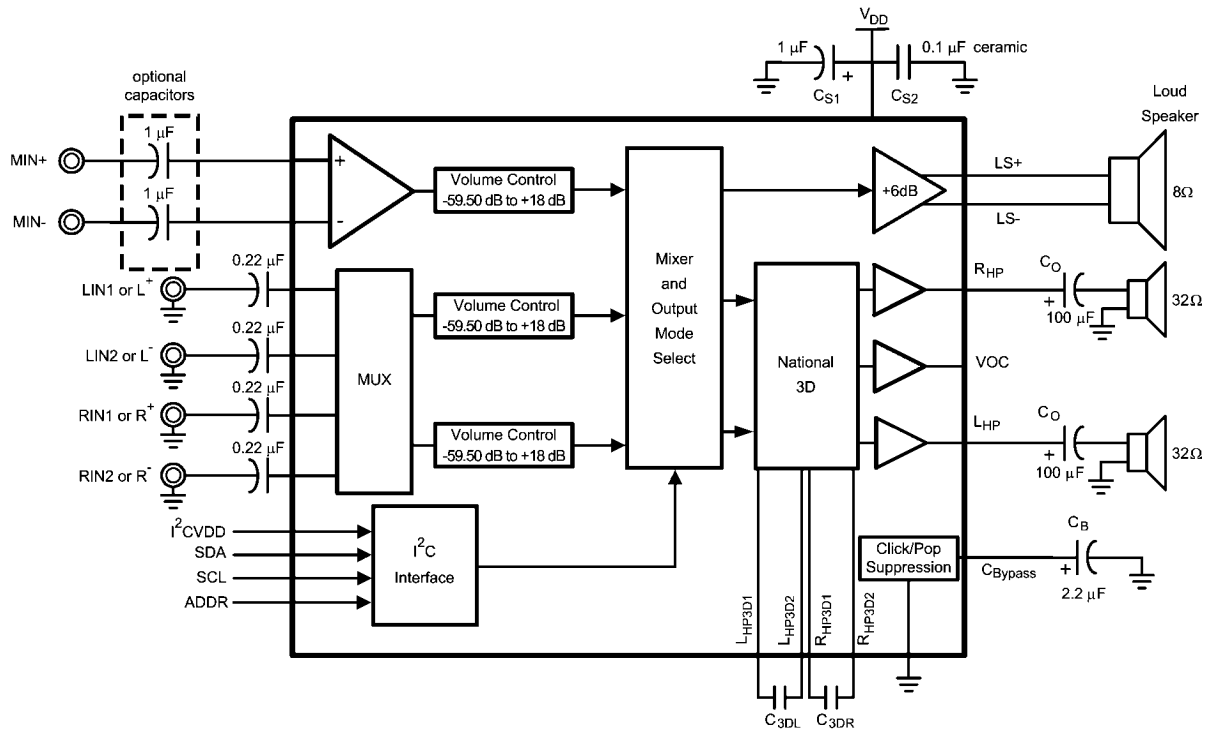

201735d4

FIGURE 2. Typical Audio Amplifier Application Circuit-Single Ended

# Connection Diagrams

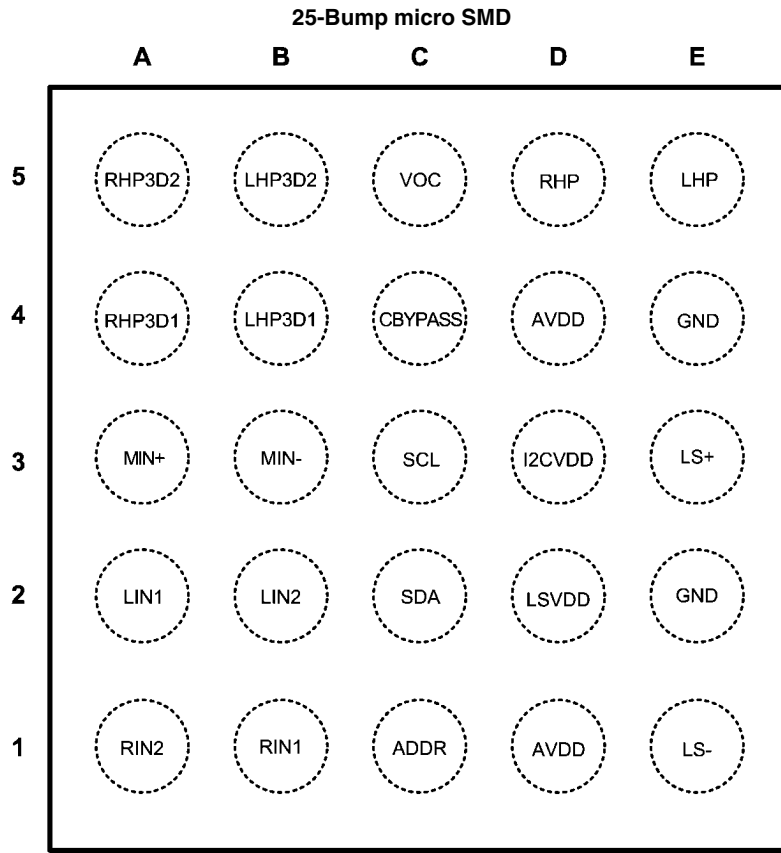

Top View

201735d2

## micro SMD Marking

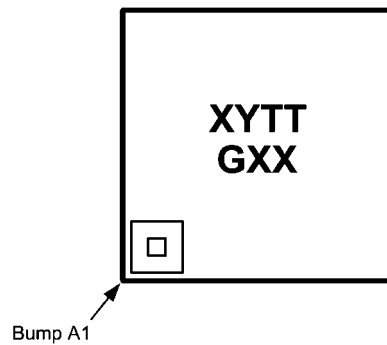

20173507

**Top View**  
**XY - Date Code**  
**TT - Die Traceability**  
**G - Boomer Family**  
**XX - H1**

## Pin Descriptions

Bump	Name	Description
A1	R <sub>IN2</sub>	Right Input Channel 2 or Right Differential Input -
A2	L <sub>IN1</sub>	Left Input Channel 1 or Left Differential Input +
A3	MIN+	Mono Channel Non-inverting Input
A4	RHP <sub>3D1</sub>	Right Headphone 3D Input 1
A5	RHP <sub>3D2</sub>	Right Headphone 3D Input 2
B1	R <sub>IN1</sub>	Right Input Channel 1 or Right Differential Input +
B2	L <sub>IN2</sub>	Left Input Channel 2 or Left Differential Input -
B3	MIN-	Mono Channel Inverting Input
B4	L <sub>HP3D1</sub>	Left Headphone 3D Input 2
B5	L <sub>HP3D2</sub>	Left Headphone 3D Input 1
C1	ADDR	Address Identification
C2	SDA	Serial Data Input
C3	SCL	Serial Clock Input
C4	C <sub>BYPASS</sub>	Half-Supply Bypass Capacitor
C5	VOC	Headphone return bias output
D1	AV <sub>DD</sub>	Analog Power Supply
D2	LSV <sub>DD</sub>	Loudspeaker Power Supply
D3	I2CV <sub>DD</sub>	I2C Interface Power Supply
D4	AV <sub>DD</sub>	Analog Power Supply
D5	R <sub>HP</sub>	Right Headphone Output
E1	LS-	Loudspeaker Output Negative
E2	GND	Ground
E3	LS+	Loudspeaker Output Positive
E4	GND	Ground
E5	L <sub>HP</sub>	Left Headphone Output

**Absolute Maximum Ratings** (Note 2)

If Military/Aerospace specified devices are required, please contact the National Semiconductor Sales Office/Distributors for availability and specifications.

Supply Voltage	6.0V
Storage Temperature	-65°C to +150°C
Input Voltage	-0.3 to $V_{DD} + 0.3$
ESD Susceptibility (Note 3)	2.0kV
ESD Machine model (Note 6)	200V
Junction Temperature ( $T_J$ )	150°C
Solder Information	

Vapor Phase (60 sec.)	215°C
Infrared (15 sec.)	220°C
Thermal Resistance	
$\theta_{JA}$ (typ) - TLA25CBA	65°C/W

**Operating Ratings**

Temperature Range	-40°C to 85°C	
Supply Voltage ( $V_{DD}$ )	$2.7V \leq V_{DD} \leq 5.5V$	
Supply Voltage ( $I^2C$ )	$2.2V \leq V_{DD} \leq 5.5V$	
Supply Voltage (Loudspeaker $V_{DD}$ )	$2.7V \leq V_{DD} \leq 5.5V$	

**Electrical Characteristics 3.3V** (Notes 2, 7)

The following specifications apply for  $V_{DD} = 3.3V$ ,  $T_A = 25^\circ C$ , and all gains are set for 0dB unless otherwise specified.

Symbol	Parameter	Conditions	LM4947		Units (Limits)
			Typical (Note 4)	Limits (Note 5)	
$I_{DDQ}$	Quiescent Supply Current	Output Modes 2, 4, 6 $V_{IN} = 0V$ ; No load, OCL = 0 (Table 2)	4.5	6.5	mA (max)
		Output Modes 1, 3, 5, 7 $V_{IN} = 0V$ ; No load, BTL, OCL = 0 (Table 2)	6.5	8	mA (max)
$I_{SD}$	Shutdown Current	Output Mode 0	0.1	1	$\mu A$ (max)
$V_{OS}$	Output Offset Voltage	$V_{IN} = 0V$ , Mode 7, Mono	2	15	mV (max)
		$V_{IN} = 0V$ , Mode 7, Headphones	2	15	mV (max)
$P_O$	Output Power	MONO <sub>OUT</sub> ; $R_L = 8\Omega$ THD+N = 1%; $f = 1kHz$ , BTL, Mode 1	500	400	mW (min)
		$R_{OUT}$ and $L_{OUT}$ ; $R_L = 32\Omega$ THD+N = 1%; $f = 1kHz$ , SE, Mode 4	37	33	mW (min)
THD+N	Total Harmonic Distortion Plus Noise	MONO <sub>OUT</sub> $f = 1kHz$ , $P_{OUT} = 250mW$ ; $R_L = 8\Omega$ , BTL, Mode 1	0.03		%
		$R_{OUT}$ and $L_{OUT}$ $f = 1kHz$ , $P_{OUT} = 12mW$ ; $R_L = 32\Omega$ , SE, Mode 4	0.02		%
$N_{OUT}$	Output Noise	A-weighted, 0dB inputs terminated, output referred			
		Speaker; Mode 1	39		$\mu V$
		Speaker; Mode 3	39		$\mu V$
		Speaker; Mode 5	42		$\mu V$
		Speaker; Mode 7	38		$\mu V$
		Headphone; SE, Mode 2	15		$\mu V$
		Headphone; SE, Mode 4	15		$\mu V$
		Headphone; SE, Mode 6	17		$\mu V$
		Headphone; OCL, Mode 2	12		$\mu V$
		Headphone; OCL, Mode 4	15		$\mu V$
	Headphone; OCL, Mode 6	17		$\mu V$	

Symbol	Parameter	Conditions	LM4947		Units (Limits)
			Typical (Note 4)	Limits (Note 5)	
PSRR	Power Supply Rejection Ratio Loudspeaker out	$V_{\text{RIPPLE}} = 200\text{mV}_{\text{PP}}$ ; $f = 217\text{Hz}$ , $R_{\text{L}} = 8\Omega$ , $C_{\text{B}} = 2.2\mu\text{F}$ , BTL All audio inputs terminated to GND; output referred			
		BTL, Output Mode 1	79		dB
		BTL, Output Mode 3	78		dB
		BTL, Output Mode 5	79		dB
		BTL, Output Mode 7	80		dB
	Power Supply Rejection Ratio $R_{\text{OUT}}$ and $L_{\text{OUT}}$	$V_{\text{RIPPLE}} = 200\text{mV}_{\text{PP}}$ ; $f = 217\text{Hz}$ , $R_{\text{L}} = 32\Omega$ , $C_{\text{B}} = 2.2\mu\text{F}$ , BTL All audio inputs terminated to GND; output referred			
		SE, Output Mode 2	78		dB
		SE, Output Mode 4	71		dB
		SE, Output Mode 6	71		dB
		OCL, Output Mode 2	83		dB
OCL, Output Mode 4		74		dB	
	OCL, Output Mode 6	74		dB	
$\eta$	Class D Efficiency	Output Mode 1, 3, 5	86		%
CMRR	Common-Mode-Rejection Ratio	$f = 217\text{Hz}$ , $V_{\text{CM}} = 1\text{V}_{\text{pp}}$ , Mode 1, BTL, $R_{\text{L}} = 8\Omega$	-49		dB
XTALK	Crosstalk	Headphone, $P_{\text{O}} = 12\text{mW}$ , $f = 1\text{kHz}$ , OCL, Mode 4, $R_{\text{L}} = 32\Omega$	-58		dB
		Headphone, $P_{\text{O}} = 12\text{mW}$ , $f = 1\text{kHz}$ , SE, Mode 4, $R_{\text{L}} = 32\Omega$	-73		dB
$T_{\text{WU}}$	Wake-Up Time from Shutdown	$C_{\text{B}} = 2.2\mu\text{F}$ , OCL, $R_{\text{L}} = 32\Omega$	90		ms
		$C_{\text{B}} = 2.2\mu\text{F}$ , SE, $R_{\text{L}} = 32\Omega$	115		ms
	Volume Control Step Size Error		$\pm 0.2$		dB
	Digital Volume Range	Input referred maximum attenuation	-59.5	-60.25 -58.75	dB (min) dB (max)
		Input referred maximum gain	+18	17.25 18.75	dB (min) dB (max)
	Mute Attenuation	Output Mode 1, 3, 5	87		dB (min)
	MONO_IN Input Impedance $R_{\text{IN}}$ and $L_{\text{IN}}$ Input Impedance	Maximum gain setting	12	8 14	$\text{k}\Omega$ (min) $\text{k}\Omega$ (max)
Maximum attenuation setting		100	75 125	$\text{k}\Omega$ (min) $\text{k}\Omega$ (max)	

## Electrical Characteristics 5V (Notes 2, 7)

The following specifications apply for  $V_{DD} = 5V$ ,  $T_A = 25^\circ C$  and all gains are set for 0dB unless otherwise specified.

Symbol	Parameter	Conditions	LM4947		Units (Limits)
			Typical (Note 4)	Limits (Note 5)	
$I_{DDQ}$	Quiescent Supply Current	Output Modes 2, 4, 6 $V_{IN} = 0V$ ; No load, OCL = 0 (Table 2)	5.4	7.5	mA
		Output Modes 1, 3, 5, 7 $V_{IN} = 0V$ ; No load, BTL, OCL = 0 (Table 2)	7.6	12	mA
$I_{SD}$	Shutdown Current	Output Mode 0	0.1	1	$\mu A$ (max)
$V_{OS}$	Output Offset Voltage	$V_{IN} = 0V$ , Mode 7, Mono	2	15	mV (max)
		$V_{IN} = 0V$ , Mode 7, Headphones	2	15	mV (max)
$P_O$	Output Power	MONO <sub>OUT</sub> ; $R_L = 8\Omega$ THD+N = 1%; $f = 1kHz$ , BTL, Mode 1	1.19		W
		$R_{OUT}$ and $L_{OUT}$ ; $R_L = 32\Omega$ THD+N = 1%; $f = 1kHz$ , SE, Mode 4	87		mW
THD+N	Total Harmonic Distortion + Noise	MONO <sub>OUT</sub> $f = 1kHz$ , $P_{OUT} = 500mW$ ; $R_L = 8\Omega$ , BTL, Mode 1	0.04		%
		$R_{OUT}$ and $L_{OUT}$ $f = 1kHz$ , $P_{OUT} = 30mW$ ; $R_L = 32\Omega$ , SE, Mode 4	0.01		%
$N_{OUT}$	Output Noise	A-weighted, 0dB inputs terminated, output referred			
		Speaker; Mode 1	38		$\mu V$
		Speaker; Mode 3	38		$\mu V$
		Speaker; Mode 5	39		$\mu V$
		Speaker; Mode 7	36		$\mu V$
		Headphone; SE, Mode 2	21		$\mu V$
		Headphone; SE, Mode 4	21		$\mu V$
		Headphone; SE, Mode 6	24		$\mu V$
		Headphone; OCL, Mode 2	16		$\mu V$
		Headphone; OCL, Mode 4	16		$\mu V$
	Headphone; OCL, Mode 6	19		$\mu V$	

Symbol	Parameter	Conditions	LM4947		Units (Limits)
			Typical (Note 4)	Limits (Note 5)	
PSRR	Power Supply Rejection Ratio Loudspeaker out	$V_{\text{RIPPLE}} = 200\text{mV}_{\text{PP}}$ ; $f = 217\text{Hz}$ , $R_{\text{L}} = 8\Omega$ , $C_{\text{B}} = 2.2\mu\text{F}$ , BTL All audio inputs terminated to GND; output referred			
		BTL, Output Mode 1	70		dB
		BTL, Output Mode 3	61		dB
		BTL, Output Mode 5	64		dB
		BTL, Output Mode 7	61		dB
	Power Supply Rejection Ratio $R_{\text{OUT}}$ and $L_{\text{OUT}}$	$V_{\text{RIPPLE}} = 200\text{mV}_{\text{PP}}$ ; $f = 217\text{Hz}$ , $R_{\text{L}} = 32\Omega$ , $C_{\text{B}} = 2.2\mu\text{F}$ , BTL All audio inputs terminated to GND; output referred			
		SE, Output Mode 2	72		dB
		SE, Output Mode 4	70		dB
		SE, Output Mode 6	65		dB
		OCL, Output Mode 2	76		dB
OCL, Output Mode 4		72		dB	
	OCL, Output Mode 6	70		dB	
$\eta$	Class D Efficiency	Output Mode 1, 3, 5	86		%
CMRR	Common-Mode Rejection Ratio	$f = 1\text{kHz}$ , $V_{\text{CM}} = 1\text{V}_{\text{pp}}$ , 0dB gain, Mode 1, BTL, $R_{\text{L}} = 8\Omega$	-49		dB
XTALK	Crosstalk	Headphone, $P_{\text{O}} = 30\text{mW}$ , $f = 1\text{kHz}$ , OCL, Mode 4	-55		dB
		Headphone, $P_{\text{O}} = 30\text{mW}$ , $f = 1\text{kHz}$ , SE, Mode 4	-72		dB
$T_{\text{WU}}$	Wake-Up Time from Shutdown	$C_{\text{B}} = 2.2\mu\text{F}$ , OCL, $R_{\text{L}} = 32\Omega$	116		ms
		$C_{\text{B}} = 2.2\mu\text{F}$ , SE, $R_{\text{L}} = 32\Omega$	150		ms
	Volume Control Step Size Error		$\pm 0.2$		dB
	Digital Volume Range	Input referred maximum attenuation	-59.5		dB
		Input referred maximum gain	+18		dB
	Mute Attenuation	Output Mode 1, 3, 5	90		dB (min)
	MONO_IN Input Impedance $R_{\text{IN}}$ and $L_{\text{IN}}$ Input Impedance	Maximum gain setting	11		k $\Omega$ (min) k $\Omega$ (max)
		Maximum attenuation setting	100		k $\Omega$ (min) k $\Omega$ (max)



**I<sup>2</sup>C** (Notes 2, 7)

The following specifications apply for  $V_{DD} = 5V$  and  $3.3V$ ,  $T_A = 25^\circ C$  unless otherwise specified.

Symbol	Parameter	Conditions	LM4947		Units (Limits)
			Typical (Note 4)	Limits (Note 5)	
$t_1$	Clock Period			2.5	$\mu s$ (max)
$t_2$	Clock Setup Time			100	ns (min)
$t_3$	Data Hold Time			100	ns (min)
$t_4$	Start Condition Time			100	ns (min)
$t_5$	Stop Condition Time			100	ns (min)
$V_{IH}$	SPI Input Voltage High			$0.7 \times I^2C$ $V_{DD}$	V (min)
$V_{IL}$	SPI Input Voltage Low			$0.3 \times I^2C$ $V_{DD}$	V (max)

**I<sup>2</sup>C Protocol Information**

The I<sup>2</sup>C address for the LM4947 is determined using the ID\_ENB pin. The LM4947's two possible I<sup>2</sup>C chip addresses are of the form 111110X<sub>1</sub>0 (binary), where X<sub>1</sub> = 0, if ID\_ADDR

is logic LOW; and X<sub>1</sub> = 1, if ID\_ENB is logic HIGH. If the I<sup>2</sup>C interface is used to address a number of chips in a system, the LM4947's chip address can be changed to avoid any possible address conflicts.

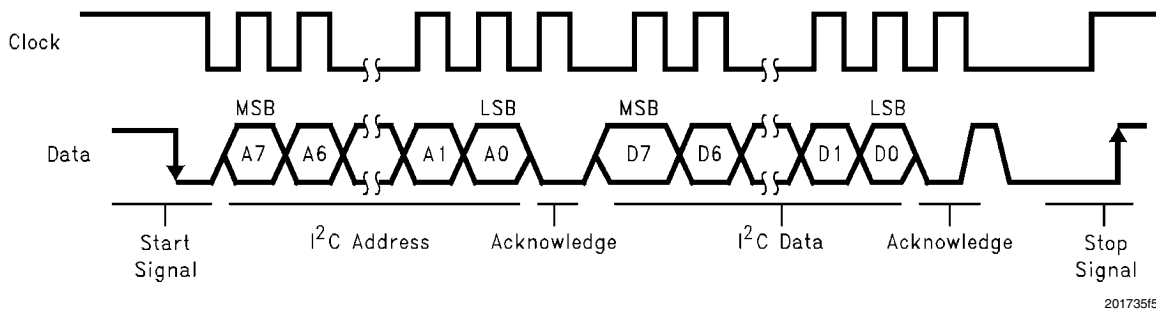

FIGURE 3. I<sup>2</sup>C Bus Format

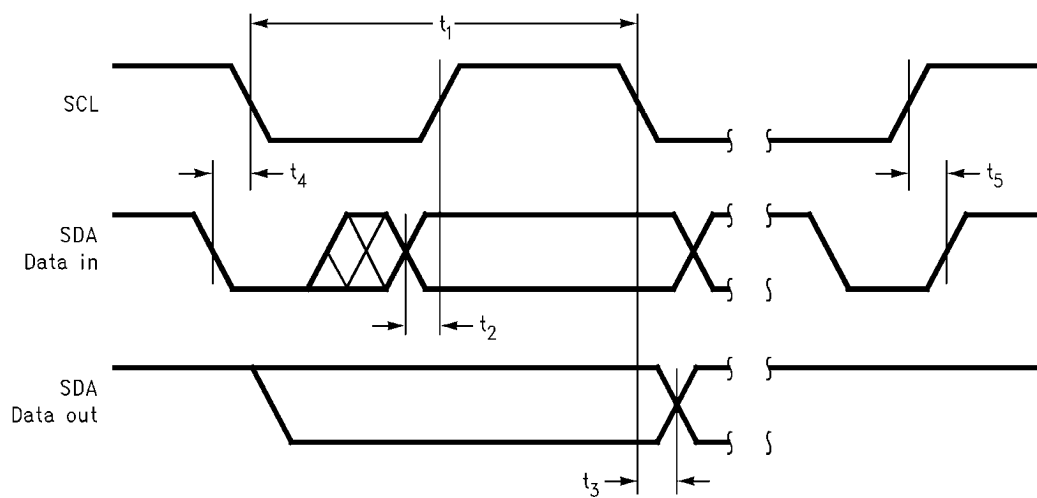

FIGURE 4. I<sup>2</sup>C Timing Diagram

**Note 1:** See AN-450 "Surface Mounting and their effects on Product Reliability" for other methods of soldering surface mount devices.

**Note 2:** Operating Ratings indicate conditions for which the device is functional, but do not guarantee specific performance limits. For guaranteed specifications and test conditions, see the Electrical Characteristics. The guaranteed specifications apply only for the test conditions listed. Some performance characteristics may degrade when the device is not operated under the listed test conditions.

**Note 3:** Human body model, 100pF discharged through a 1.5k $\Omega$  resistor.

**Note 4:** Typical specifications are specified at +25°C and represent the most likely parametric norm.

**Note 5:** Tested limits are guaranteed to National's AOQL (Average Outgoing Quality Level).

**Note 6:** Machine Model ESD test is covered by specification EIAJ IC-121-1981. A 200pF cap is charged to the specified voltage, then discharged directly into the IC with no external series resistor (resistance of discharge path must be under 50 $\Omega$ ).

**Note 7:** All voltages are measured with respect to the ground pin, unless otherwise specified.

**Note 8:** The given  $\theta_{JA}$  for an LM4947TL mounted on a demonstration board with a 9in<sup>2</sup> area of 1oz printed circuit board copper ground plane.

**Note 9:** Datasheet min/max specifications are guaranteed by design, test, or statistical analysis.

# Typical Performance Characteristics

**THD+N vs Output Power**  
 $V_{DD} = 3.3V, R_L = 8\Omega, f = 1kHz$   
**Mode 1, MONO**

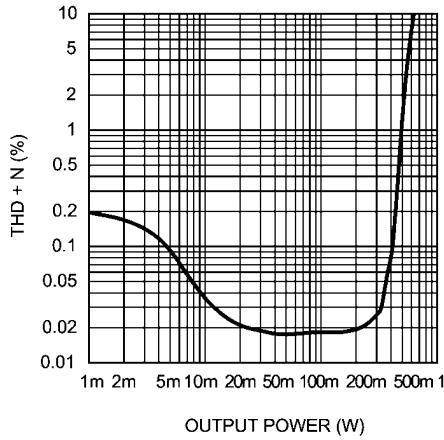

20173543

**THD+N vs Output Power**  
 $V_{DD} = 3.3V, R_L = 8\Omega, f = 1kHz$   
**Mode 3, MONO**

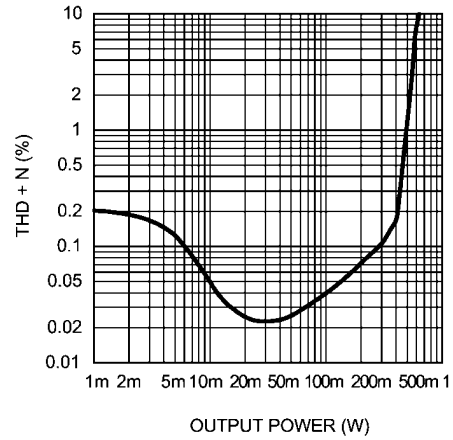

20173544

**THD+N vs Output Power**  
 $V_{DD} = 3.3V, R_L = 8\Omega, f = 1kHz$   
**Mode 5, MONO**

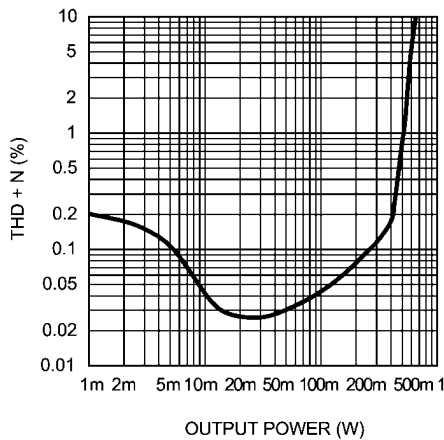

20173545

**THD+N vs Output Power**  
 $V_{DD} = 3.3V, R_L = 32\Omega, f = 1kHz, \text{Diff In}$   
**Mode 2, OCL**

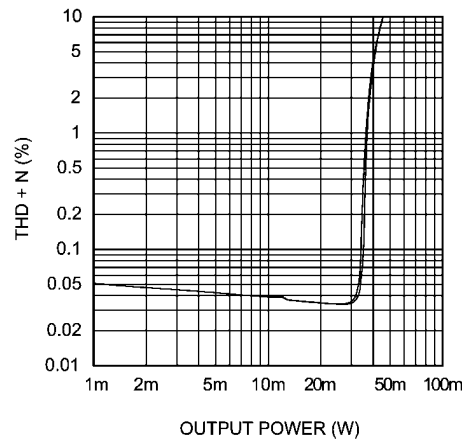

20173546

**THD+N vs Output Power**  
 $V_{DD} = 3.3V, R_L = 32\Omega, f = 1kHz, \text{Diff In}$   
**Mode 2, SE**

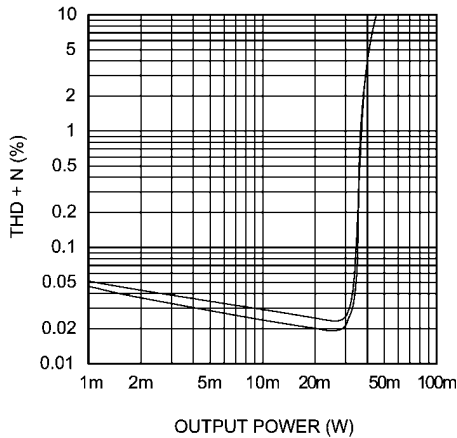

20173547

**THD+N vs Output Power**  
 $V_{DD} = 3.3V, R_L = 32\Omega, f = 1kHz, \text{Diff In}$   
**Mode 4, OCL**

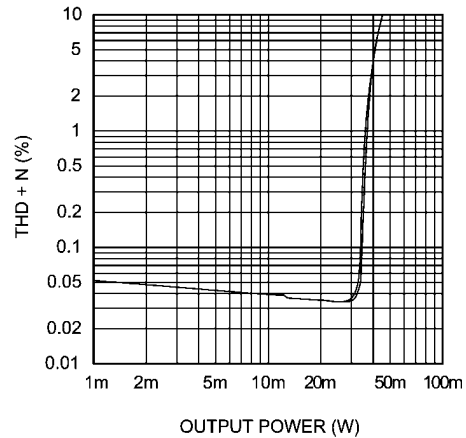

20173548

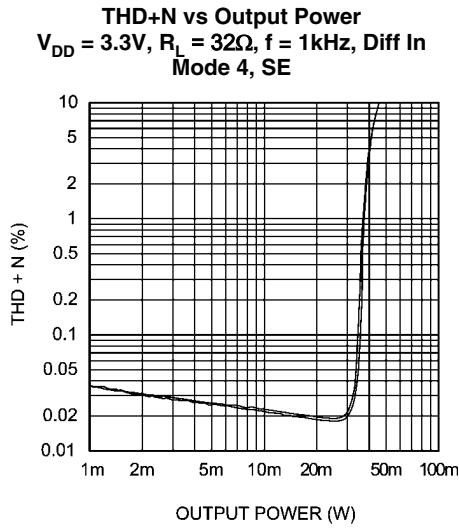

20173549

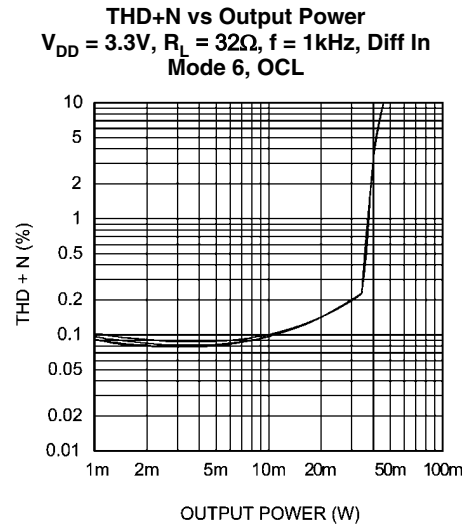

20173550

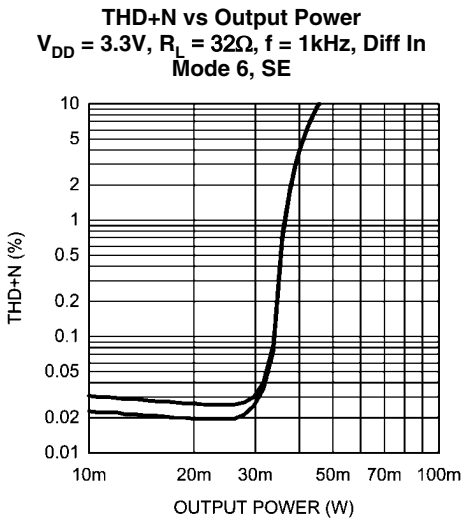

20173515

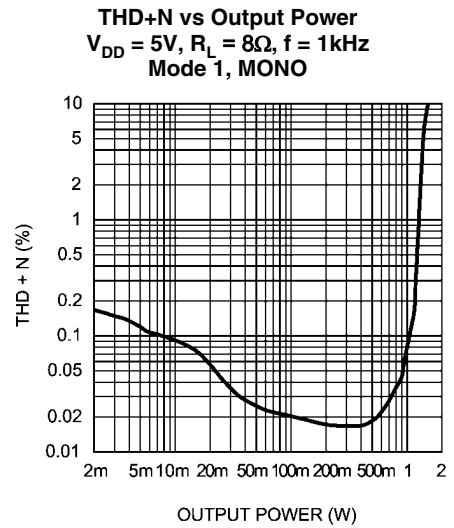

20173552

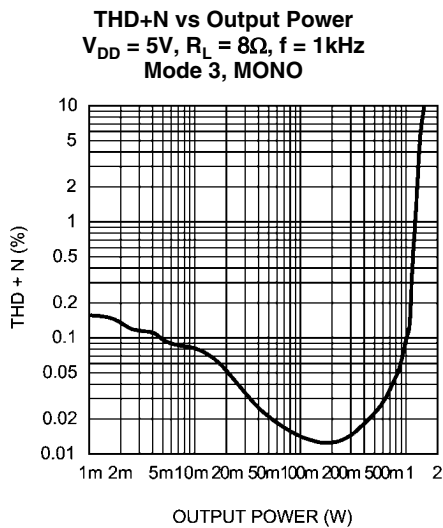

20173553

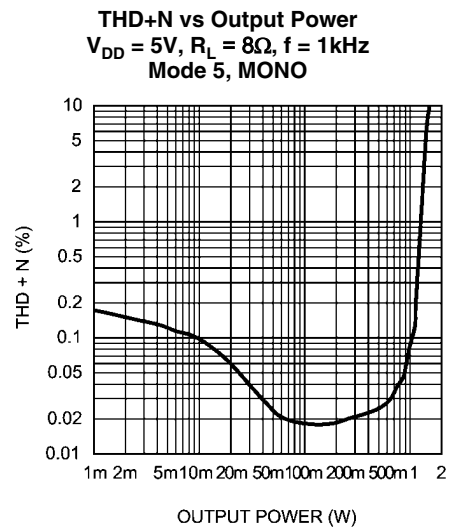

20173554

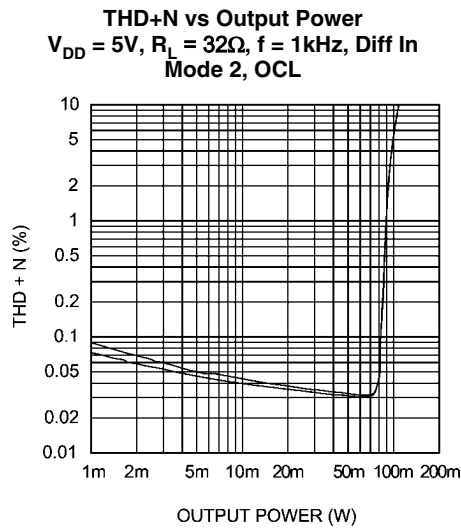

20173555

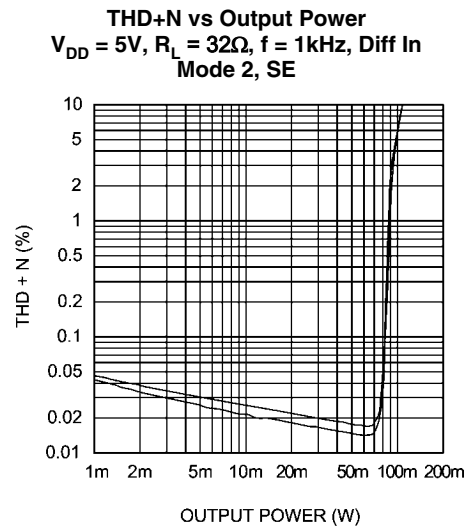

20173556

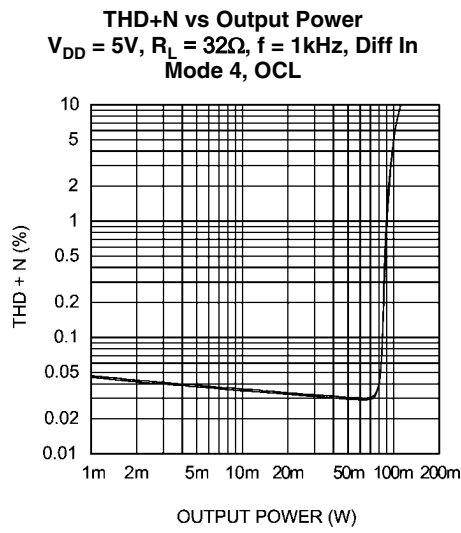

20173557

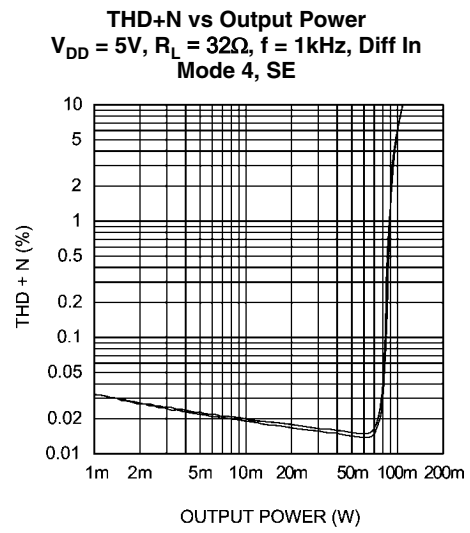

20173558

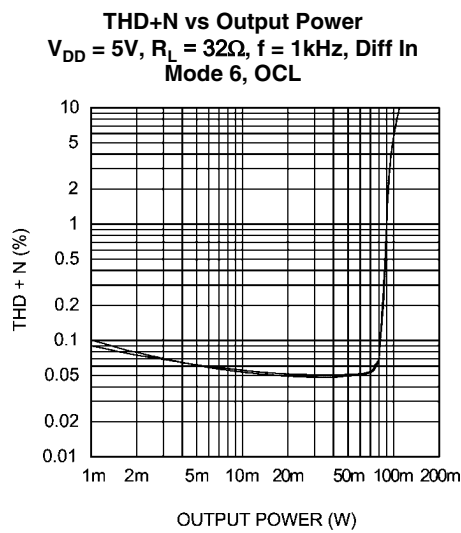

20173559

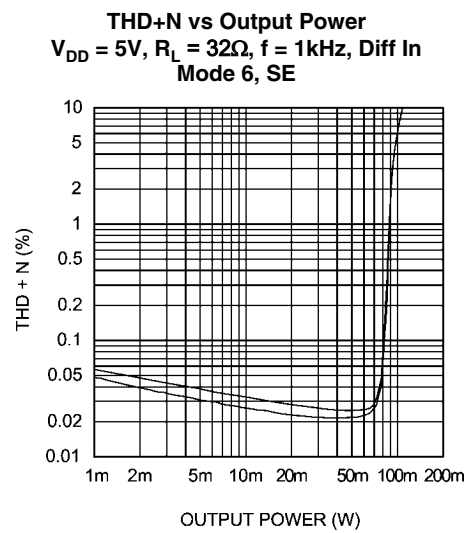

20173560

**THD+N vs Frequency**  
 $V_{DD} = 3.3V, R_L = 8\Omega, P_O = 250mW$   
 Diff In, Mode 1

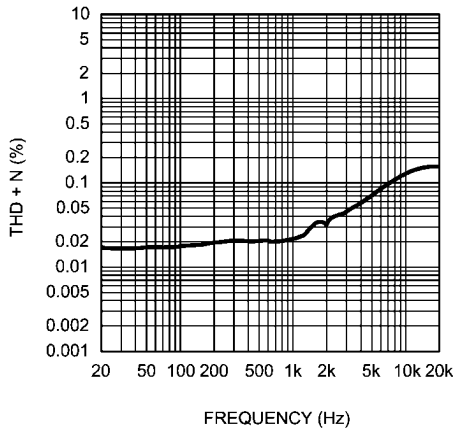

20173525

**THD+N vs Frequency**  
 $V_{DD} = 3.3V, R_L = 8\Omega, P_O = 250mW$   
 Diff In, Mode 5

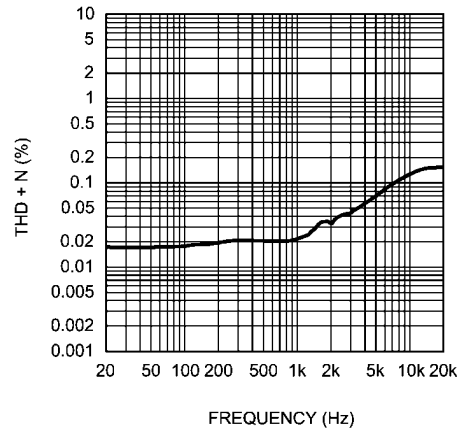

20173526

**THD+N vs Frequency**  
 $V_{DD} = 3.3V, R_L = 8\Omega, P_O = 250mW$   
 Diff In, Mode 3

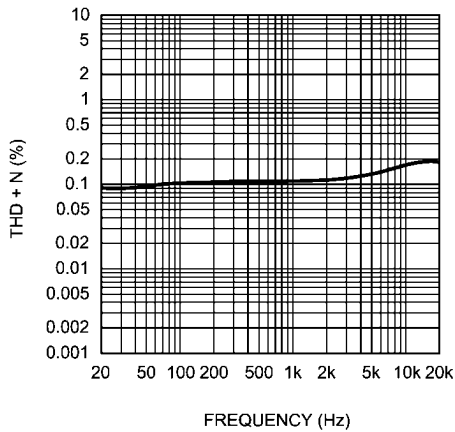

20173527

**THD+N vs Frequency**  
 $V_{DD} = 3.3V, R_L = 32\Omega, P_O = 12mW$   
 Mode 2, OCL

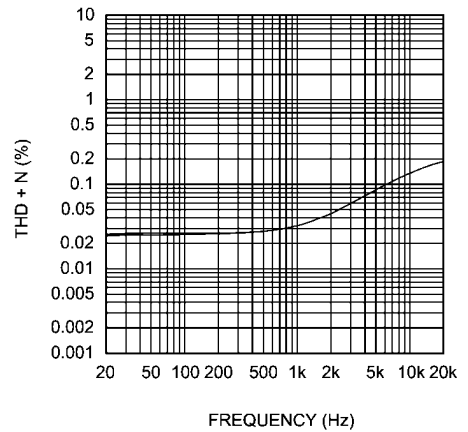

20173528

**THD+N vs Frequency**  
 $V_{DD} = 3.3V, R_L = 32\Omega, P_O = 12mW$   
 Mode 2, SE

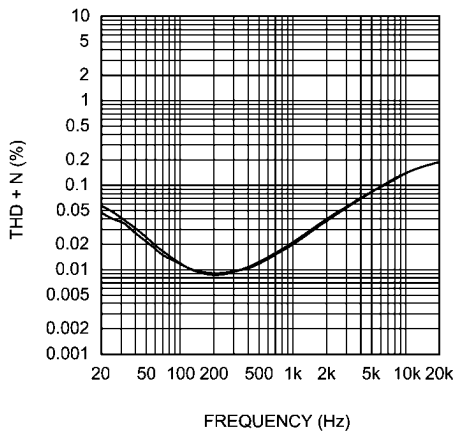

20173529

**THD+N vs Frequency**  
 $V_{DD} = 3.3V, R_L = 32\Omega, P_O = 12mW$   
 Mode 4,7, OCL

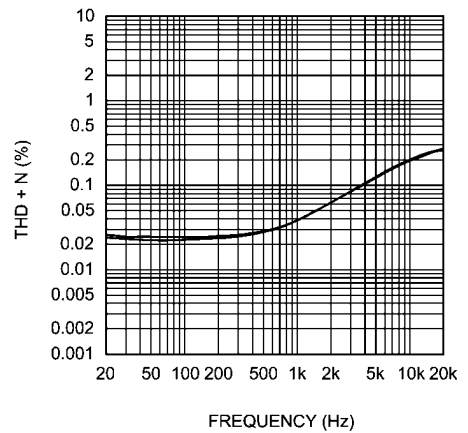

20173530

**THD+N vs Frequency**  
 $V_{DD} = 3.3V, R_L = 32\Omega, P_O = 12mW$   
 Mode 4,7, SE

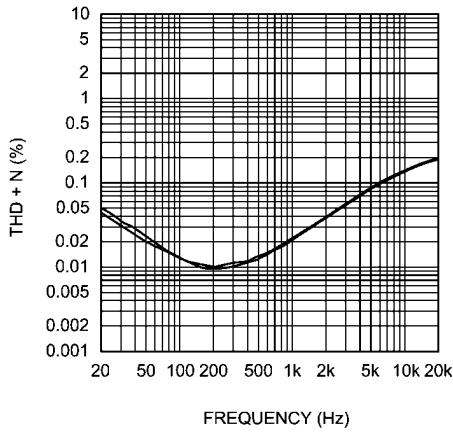

20173531

**THD+N vs Frequency**  
 $V_{DD} = 3.3V, R_L = 32\Omega, P_O = 12mW$   
 Mode 6, OCL

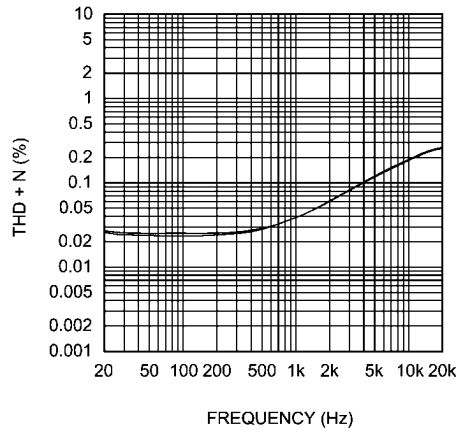

20173532

**THD+N vs Frequency**  
 $V_{DD} = 3.3V, R_L = 32\Omega, P_O = 12mW$   
 Mode 6, SE

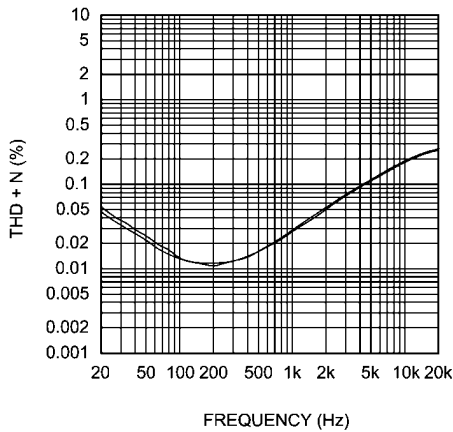

20173533

**THD+N vs Frequency**  
 $V_{DD} = 5V, R_L = 8\Omega, P_O = 500mW$   
 Diff In, Mode 1

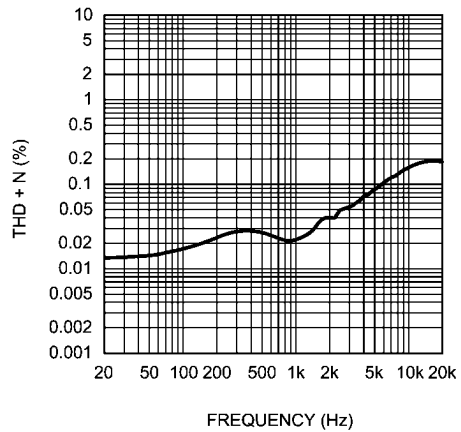

20173534

**THD+N vs Frequency**  
 $V_{DD} = 5V, R_L = 8\Omega, P_O = 500mW$   
 Diff In, Mode 3

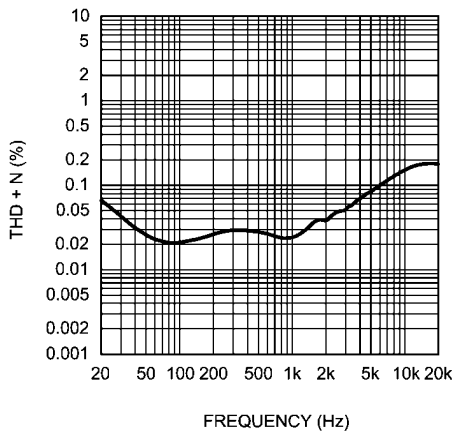

20173535

**THD+N vs Frequency**  
 $V_{DD} = 5V, R_L = 8\Omega, P_O = 500mW$   
 Diff In, Mode 5

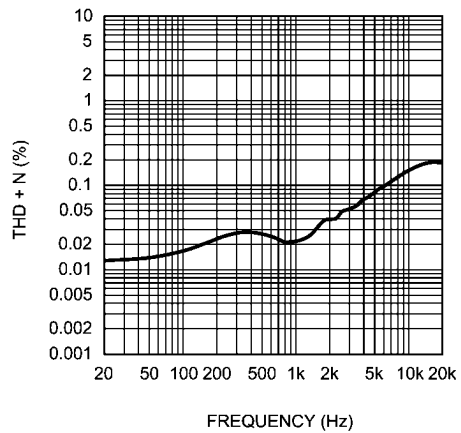

20173536

**THD+N vs Frequency**  
 $V_{DD} = 5V, R_L = 32\Omega, P_O = 30mW$   
 Diff In, Mode 2, OCL

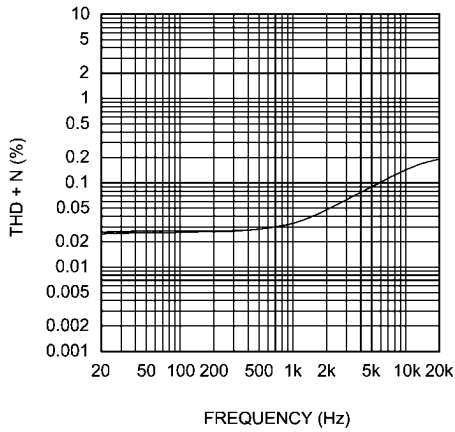

20173537

**THD+N vs Frequency**  
 $V_{DD} = 5V, R_L = 32\Omega, P_O = 30mW$   
 Diff In, Mode 2, SE

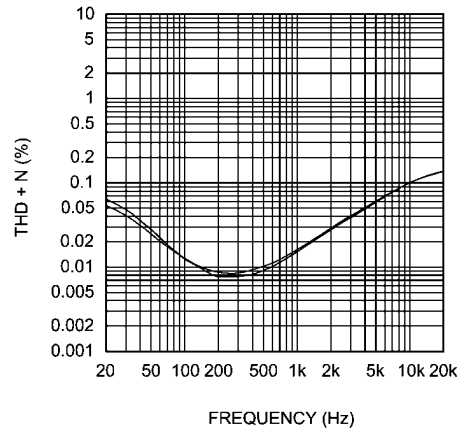

20173538

**THD+N vs Frequency**  
 $V_{DD} = 5V, R_L = 32\Omega, P_O = 30mW$   
 Diff In, Mode 4,7, OCL

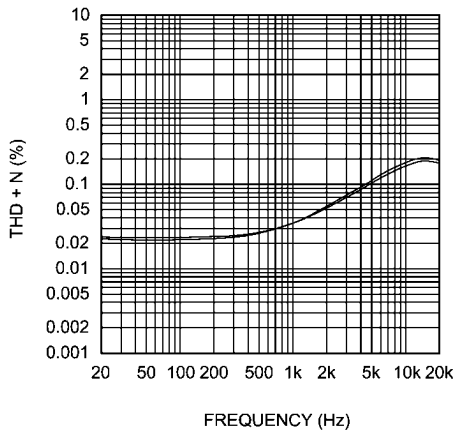

20173539

**THD+N vs Frequency**  
 $V_{DD} = 5V, R_L = 32\Omega, P_O = 30mW$   
 Diff In, Mode 4,7, SE

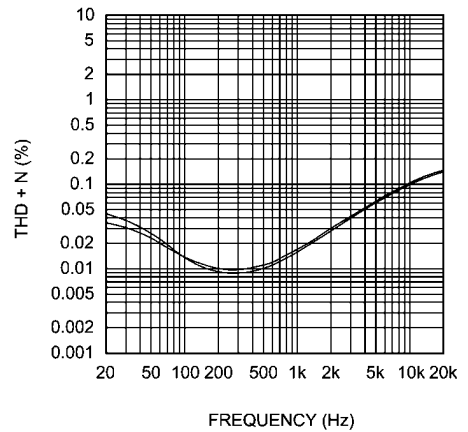

20173540

**THD+N vs Frequency**  
 $V_{DD} = 5V, R_L = 32\Omega, P_O = 30mW$   
 Diff In, Mode 6, OCL

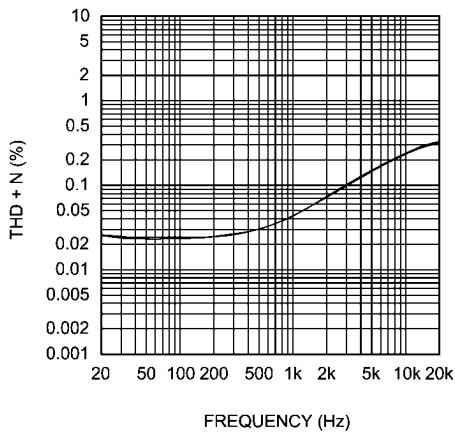

20173541

**THD+N vs Frequency**  
 $V_{DD} = 5V, R_L = 32\Omega, P_O = 30mW$   
 Diff In, Mode 6, SE

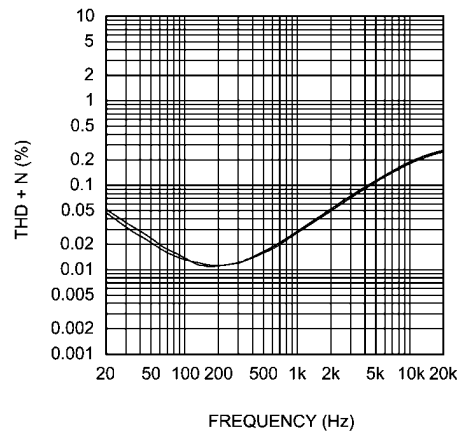

20173542



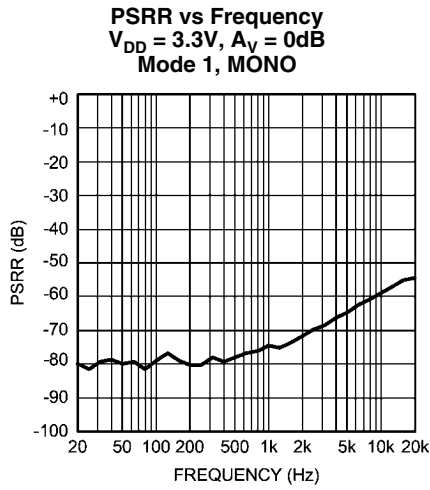

20173516

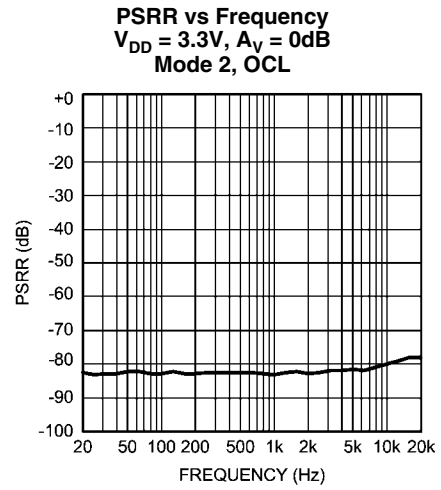

20173517

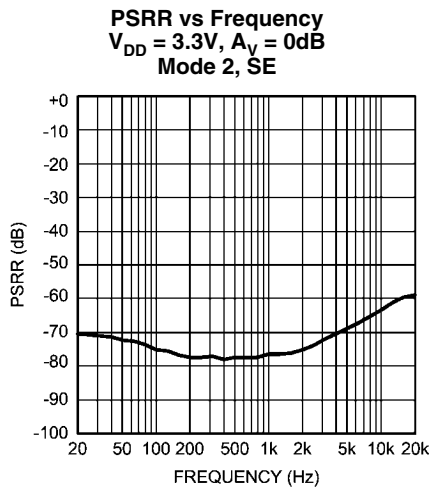

20173518

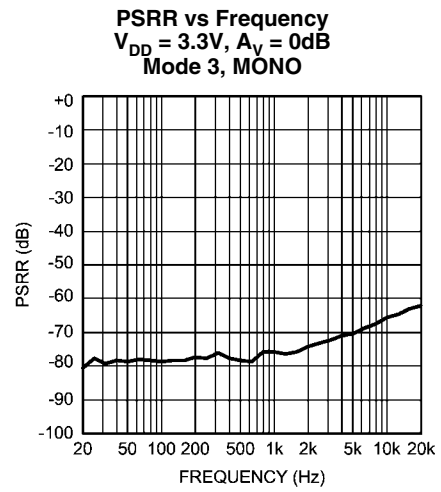

20173519

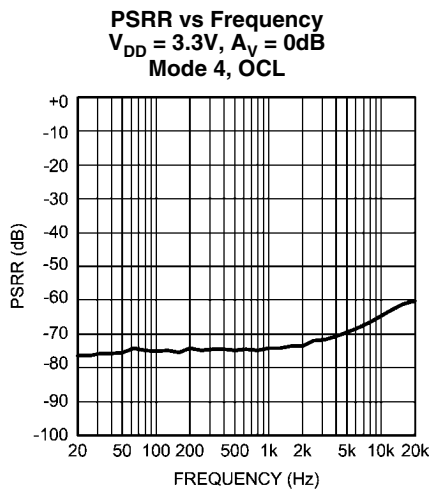

20173520

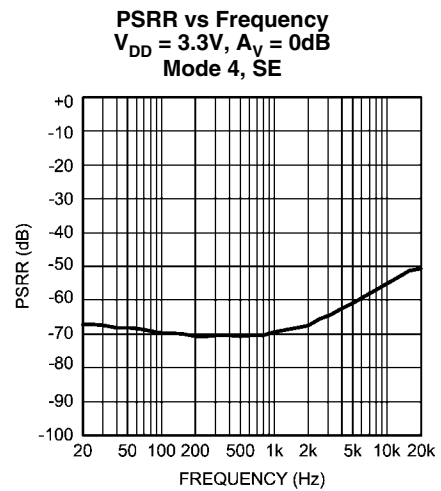

20173521

**PSRR vs Frequency**  
 $V_{DD} = 3.3V, A_V = 0dB$   
**Mode 5, MONO**

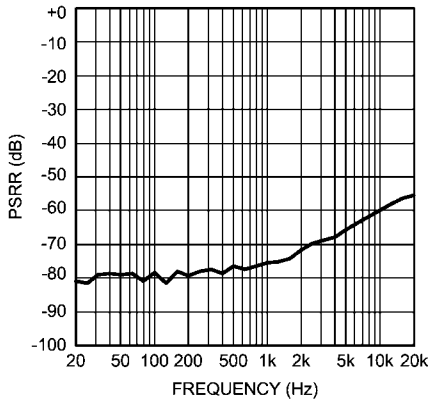

20173522

**PSRR vs Frequency**  
 $V_{DD} = 3.3V, A_V = 0dB$   
**Mode 6, OCL**

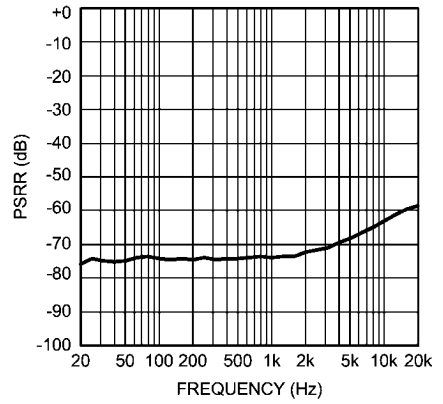

20173523

**PSRR vs Frequency**  
 $V_{DD} = 3.3V, A_V = 0dB$   
**Mode 6, SE**

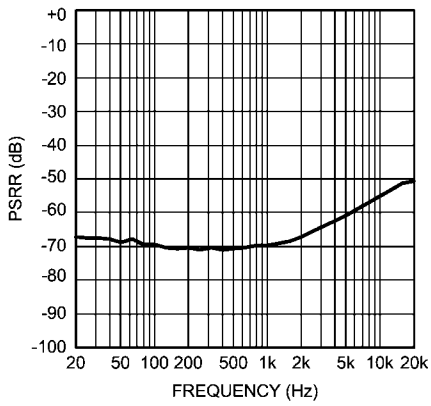

201735a4

**PSRR vs Frequency**  
 $V_{DD} = 3.3V, A_V = 0dB$   
**Mode 7, MONO**

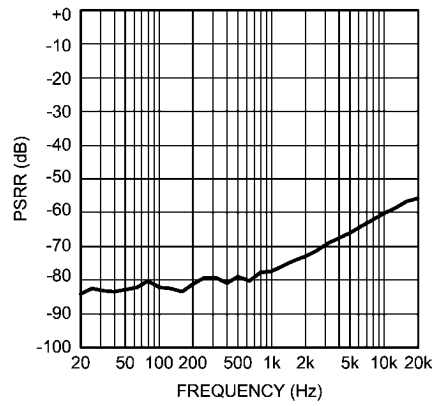

201735a5

**PSRR vs Frequency**  
 $V_{DD} = 5V, A_V = 0dB$   
**Mode 1, MONO**

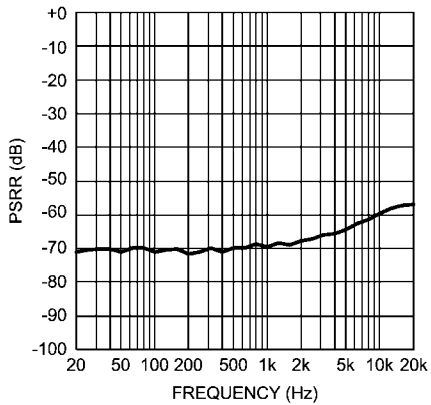

201735a6

**PSRR vs Frequency**  
 $V_{DD} = 5V, A_V = 0dB$   
**Mode 2, OCL**

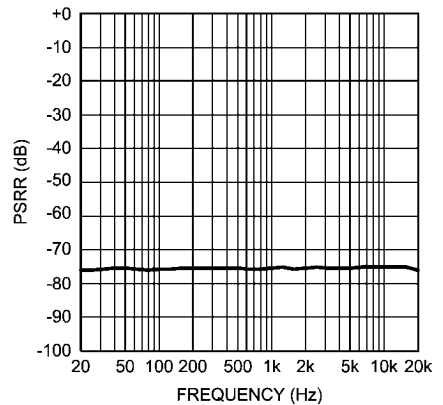

201735a7

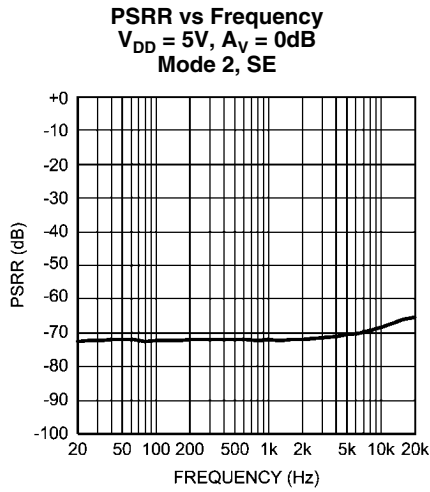

201735a8

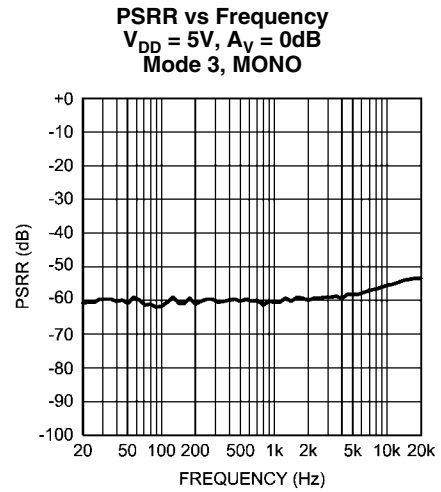

201735a9

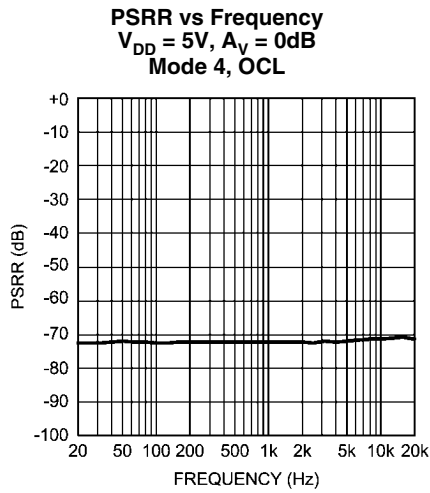

201735b0

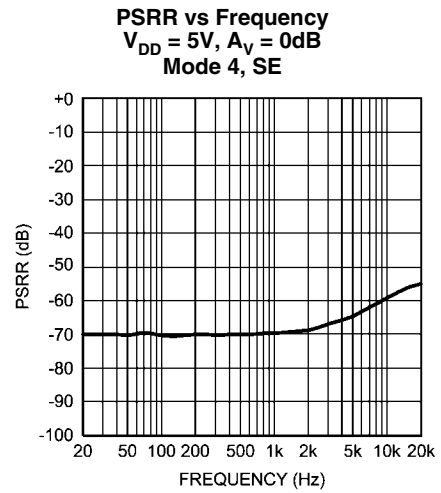

201735b1

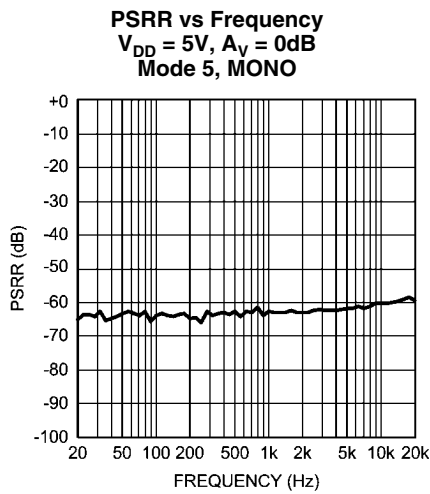

201735b2

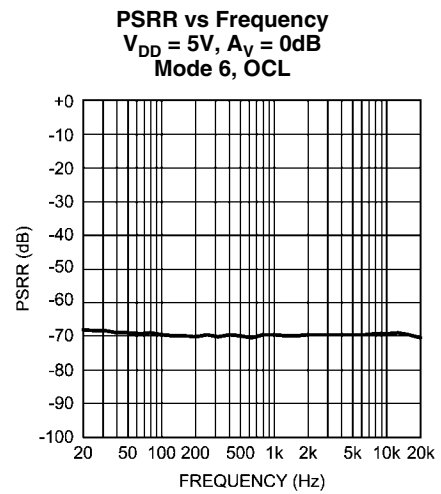

201735b3

**PSRR vs Frequency**  
 $V_{DD} = 5V, A_V = 0dB$   
**Mode 6, SE**

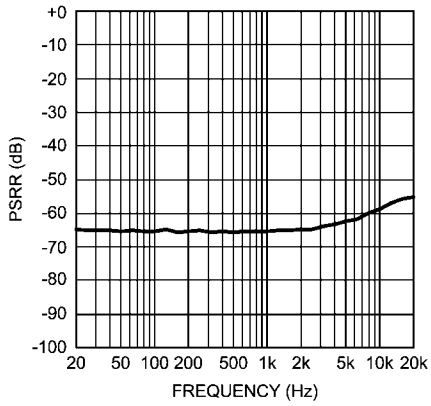

201735b4

**PSRR vs Frequency**  
 $V_{DD} = 5V, A_V = 0dB$   
**Mode 7, MONO**

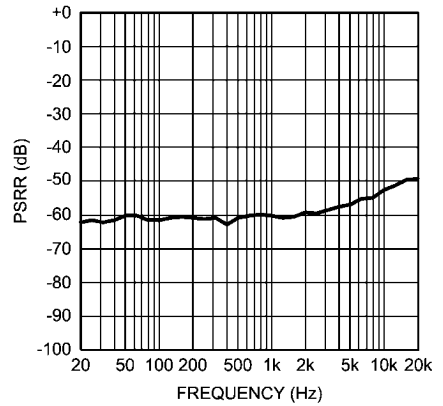

201735b5

**Power Dissipation vs Output Power**  
 $V_{DD} = 3.3V, R_L = 32\Omega, f = 1kHz$   
**Mode 7, OCL**

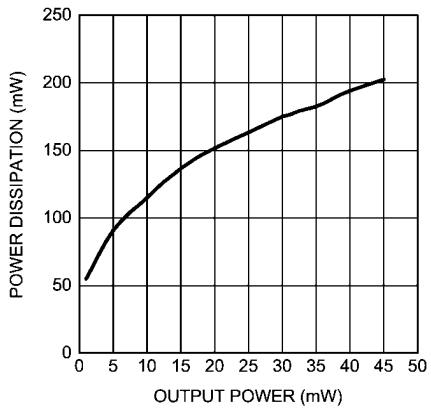

201735c9

**Power Dissipation vs Output Power**  
 $V_{DD} = 3.3V, R_L = 32\Omega, f = 1kHz$   
**Mode 7, SE**

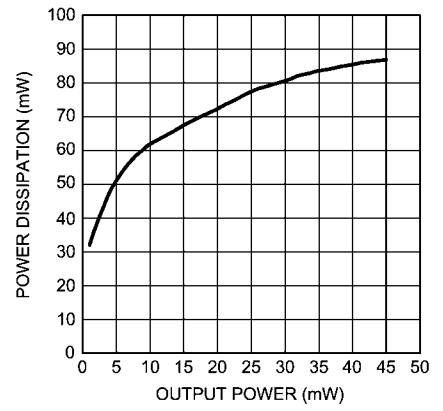

201735d0

**Power Dissipation vs Output Power**  
 $V_{DD} = 3.3V, R_L = 8\Omega, f = 1kHz$   
**Mode 1, 3, 5, MONO**

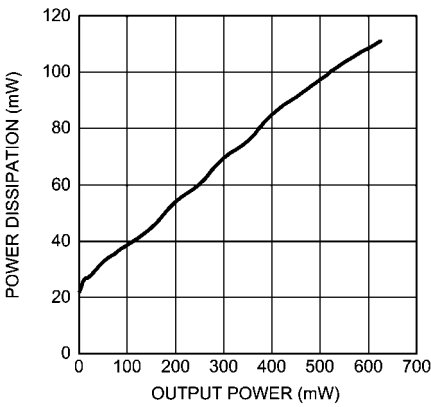

201735c8

**Power Dissipation vs Output Power**  
 $V_{DD} = 3.3V, R_L = 32\Omega, f = 1kHz$   
**Mode 2, 4, 6, OCL**

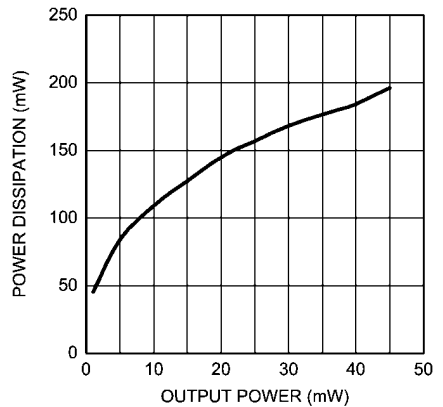

201735b6

**Power Dissipation vs Output Power**  
 $V_{DD} = 3.3V, R_L = 32\Omega, f = 1kHz$   
 Mode 2, 4, 6, SE

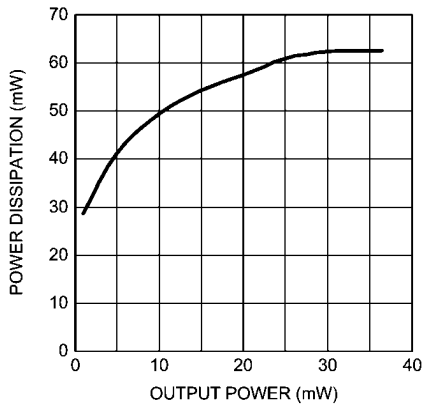

20173598

**Power Dissipation vs Output Power**  
 $V_{DD} = 5V, R_L = 32\Omega, f = 1kHz$   
 Mode 7, OCL

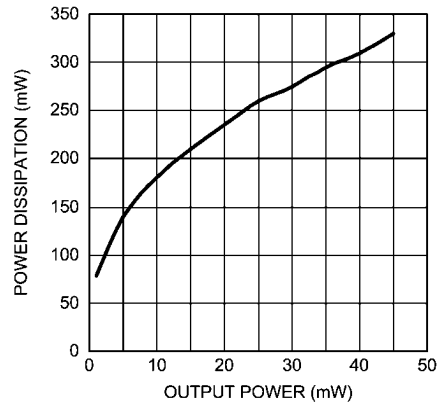

201735e0

**Power Dissipation vs Output Power**  
 $V_{DD} = 5V, R_L = 32\Omega, f = 1kHz$   
 Mode 7, SE

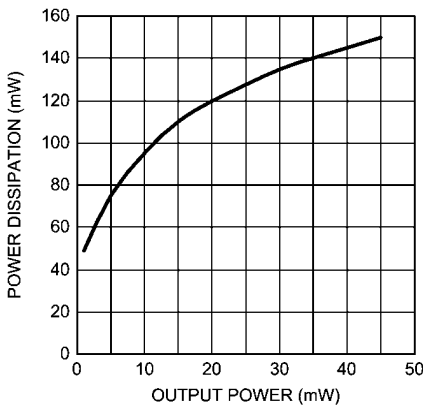

201735e1

**Power Dissipation vs Output Power**  
 $V_{DD} = 5V, R_L = 8\Omega, f = 1kHz$   
 Mode 1, 3, 5, MONO

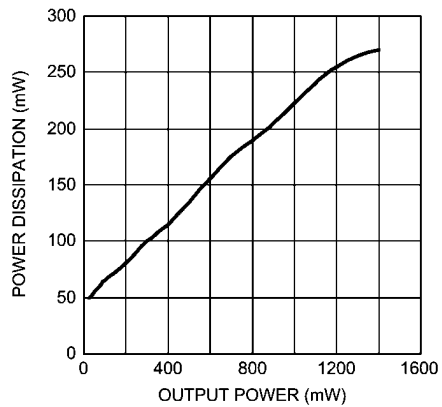

201735b7

**Power Dissipation vs Output Power**  
 $V_{DD} = 5V, R_L = 32\Omega, f = 1kHz$   
 Mode 2, 4, 6, OCL

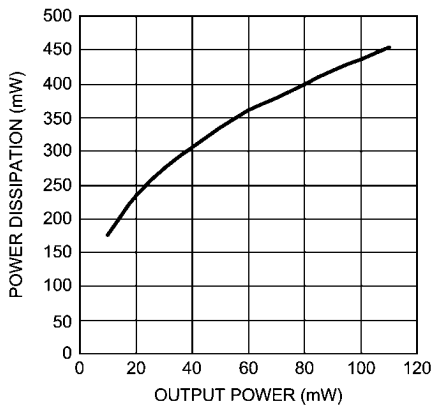

201735b8

**Power Dissipation vs Output Power**  
 $V_{DD} = 5V, R_L = 32\Omega, f = 1kHz$   
 Mode 2, 4, 6, SE

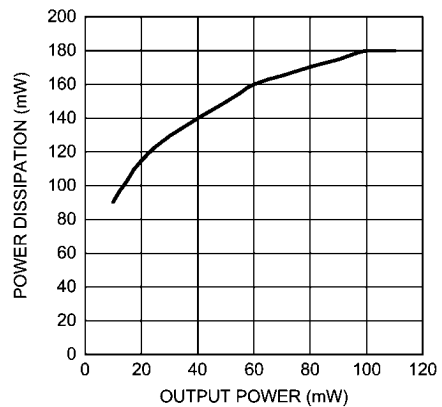

201735b9

**Crosstalk vs Frequency**  
 $V_{DD} = 3.3V, R_L = 32\Omega, P_O = 12mW$   
 Mode 4, OCL

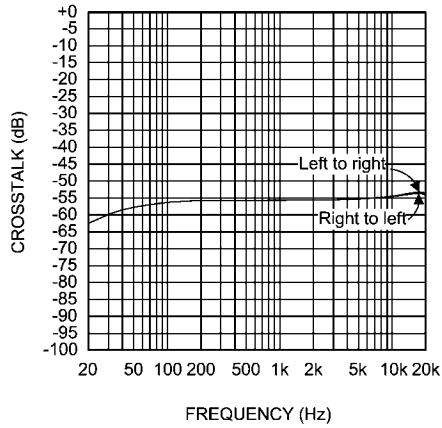

20173573

**Crosstalk vs Frequency**  
 $V_{DD} = 3.3V, R_L = 32\Omega, P_O = 12mW$   
 Mode 4, SE

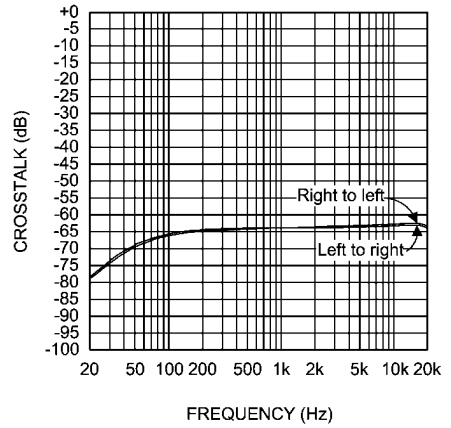

20173574

**Crosstalk vs Frequency**  
 $V_{DD} = 5V, R_L = 32\Omega, P_O = 30mW$   
 Mode 4, OCL

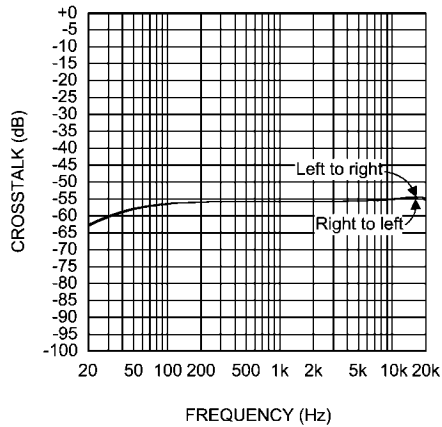

20173575

**Crosstalk vs Frequency**  
 $V_{DD} = 5V, R_L = 32\Omega, P_O = 30mW$   
 Mode 4, SE

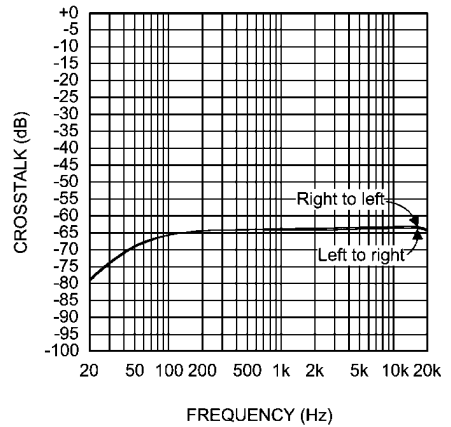

20173576

**Supply Current vs Supply Voltage**  
 No Load, Mode 7, OCL

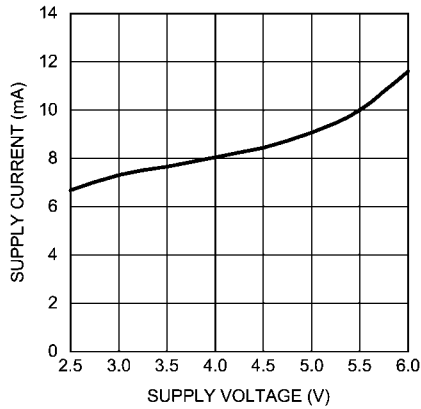

201735c2

**Supply Current vs Supply Voltage**  
 No Load, Mode 7, SE

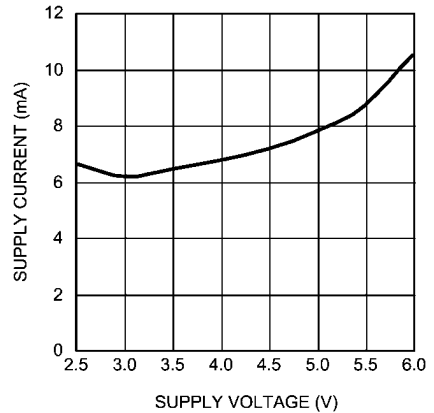

20173578

**Supply Current vs Supply Voltage**  
No Load, Mode 1, 3, 5, MONO

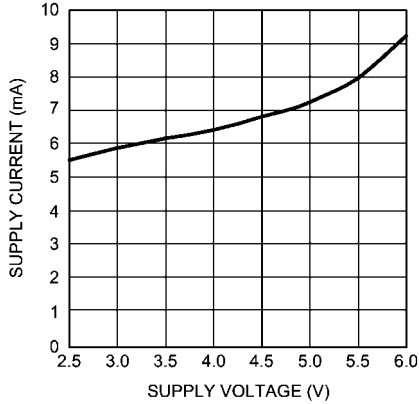

201735d1

**Supply Current vs Supply Voltage**  
No Load, Mode 2, 4, 6, OCL

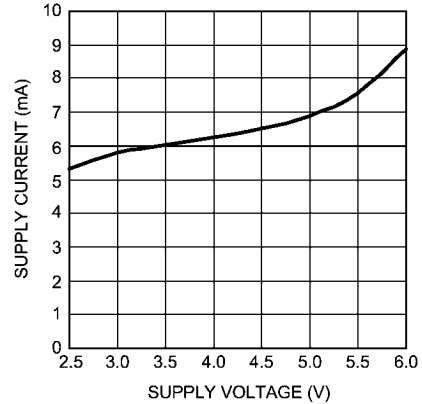

201735e4

**Supply Current vs Supply Voltage**  
No Load, Mode 2, 4, 6, Headphone SE

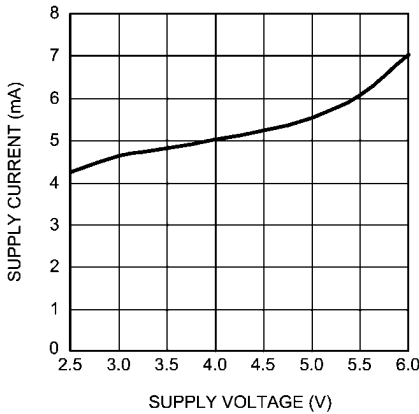

20173581

**Output Power vs Supply Voltage**  
 $R_L = 8\Omega$ , Mode 1, 3, 5, MONO

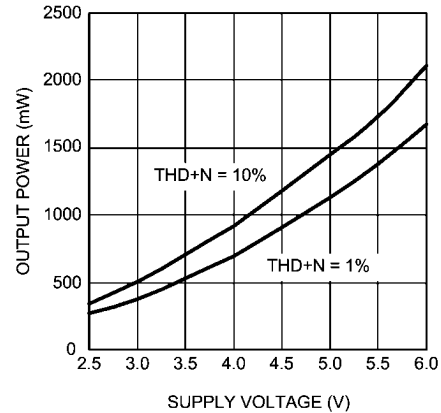

20173587

**Output Power vs Supply Voltage**  
 $R_L = 32\Omega$ , Mode 2, 4, 6, OCL

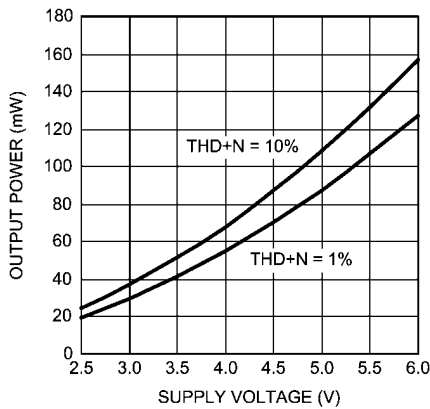

201735e7

**Output Power vs Supply Voltage**  
 $R_L = 32\Omega$ , Mode 2, 4, 6, SE

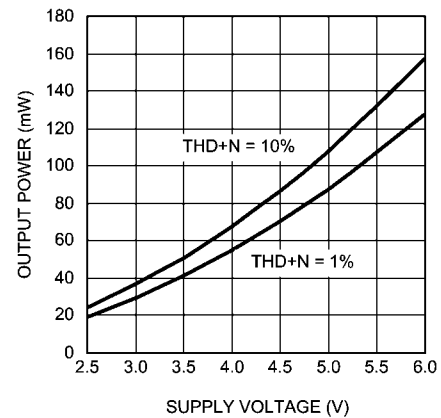

20173589

**Output Power vs Supply Voltage**  
 $R_L = 32\Omega$ , Mode 7, OCL

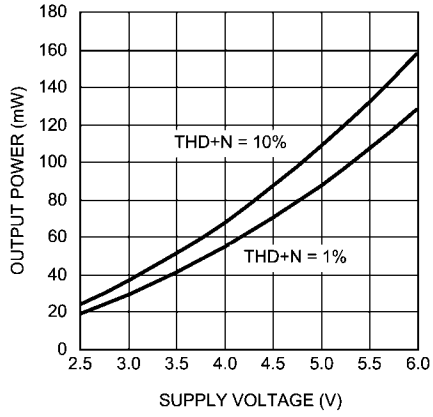

20173590

**Output Power vs Supply Voltage**  
 $R_L = 32\Omega$ , Mode 7, SE

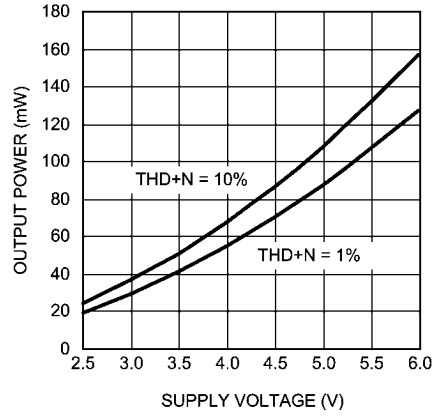

20173591

**Efficiency vs Output Power**  
 $V_{DD} = 3.3V$ ,  $R_L = 8\Omega$ , Mode 1, 3, 5, BTL

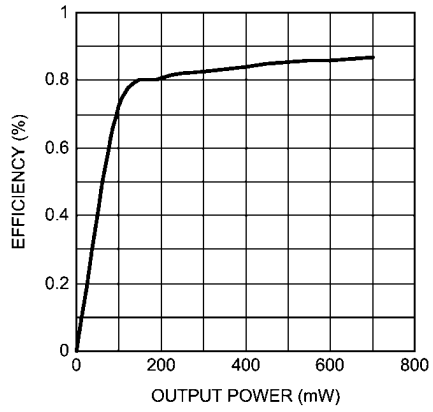

20173513

**Efficiency vs Output Power**  
 $V_{DD} = 5V$ ,  $R_L = 8\Omega$ , Mode 1, 3, 5, BTL

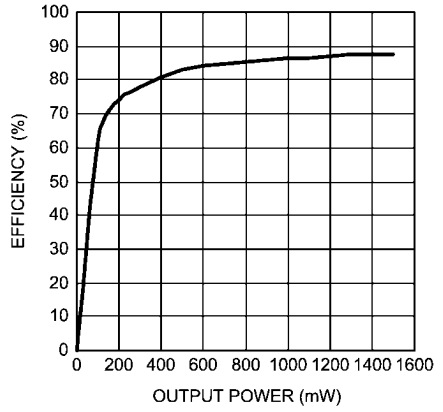

20173566



## Application Information

### I<sup>2</sup>C PIN DESCRIPTION

SDA: This is the serial data input pin.

SCL: This is the clock input pin.

ID\_ENB: This is the address select input pin.

### I<sup>2</sup>C COMPATIBLE INTERFACE

The LM4947 uses a serial bus which conforms to the I<sup>2</sup>C protocol to control the chip's functions with two wires: clock (SCL) and data (SDA). The clock line is uni-directional. The data line is bi-directional (open-collector). The maximum clock frequency specified by the I<sup>2</sup>C standard is 400kHz. In this discussion, the master is the controlling microcontroller and the slave is the LM4947.

The I<sup>2</sup>C address for the LM4947 is determined using the ID\_ENB pin. The LM4947's two possible I<sup>2</sup>C chip addresses are of the form 11110X<sub>1</sub>0 (binary), where X<sub>1</sub> = 0, if ID\_ADDR is logic LOW; and X<sub>1</sub> = 1, if ID\_ENB is logic HIGH. If the I<sup>2</sup>C interface is used to address a number of chips in a system, the LM4947's chip address can be changed to avoid any possible address conflicts.

The bus format for the I<sup>2</sup>C interface is shown in Figure 3. The bus format diagram is broken up into six major sections:

The "start" signal is generated by lowering the data signal while the clock signal is HIGH. The start signal will alert all devices attached to the I<sup>2</sup>C bus to check the incoming address against their own address.

The 8-bit chip address is sent next, most significant bit first. The data is latched in on the rising edge of the clock. Each address bit must be stable while the clock level is HIGH.

After the last bit of the address bit is sent, the master releases the data line HIGH (through a pull-up resistor). Then the master sends an acknowledge clock pulse. If the LM4947 has received the address correctly, then it holds the data line LOW during the clock pulse. If the data line is not held LOW during the acknowledge clock pulse, then the master should abort the rest of the data transfer to the LM4947.

The 8 bits of data are sent next, most significant bit first. Each data bit should be valid while the clock level is stable HIGH.

After the data byte is sent, the master must check for another acknowledge to see if the LM4947 received the data.

The "stop" signal ends the transfer. To signal "stop", the data signal goes HIGH while the clock signal is HIGH. The data line should be held HIGH when not in use.

### I<sup>2</sup>C INTERFACE POWER SUPPLY PIN (I<sup>2</sup>CV<sub>DD</sub>)

The LM4947's I<sup>2</sup>C interface is powered up through the I<sup>2</sup>CV<sub>DD</sub> pin. The LM4947's I<sup>2</sup>C interface operates at a voltage level set by the I<sup>2</sup>CV<sub>DD</sub> pin which can be set independent to that of the main power supply pin V<sub>DD</sub>. This is ideal whenever logic levels for the I<sup>2</sup>C interface are dictated by a microcontroller or microprocessor that is operating at a lower supply voltage than the main battery of a portable system.

TABLE 1. Chip Address

	A7	A6	A5	A4	A3	A2	A1	A0
Chip Address	1	1	1	1	1	0	EC	0
ID_ADDR = 0	1	1	1	1	1	0	0	0
ID_ADDR = 1	1	1	1	1	1	0	1	0

TABLE 2. Control Registers

	D7	D6	D5	D4	D3	D2	D1	D0
Mode Control	0	0	SE/Diff (select)	0	OCL (select)	MC2	MC1	MC0
Programmable 3D	0	1	L2R2 (select)	L1R1 (select)	N3D3	N3D2	N3D1	N3D0
Mono Volume Control	1	0	0	MVC4	MVC3	MVC2	MVC1	MVC0
Left Volume Control	1	1	0	LVC4	LVC3	LVC2	LVC1	LVC0
Right Volume Control	1	1	1	RVC4	RVC3	RVC2	RVC1	RVC0

1. Bits MVC0 — MVC4 control 32 step volume control for MONO input
2. Bits LVC0 — LVC4 control 32 step volume control for LEFT input
3. Bits RVC0 — RVC4 control 32 step volume control for RIGHT input
4. Bits MC0 — MC2 control 8 distinct modes
5. Bits N3D3, N3D2, N3D1, N3D0 control programmable 3D function
6. N3D0 turns the 3D function ON (N3D0 = 1) or OFF (N3D0 = 0)
7. Bit OCL selects between SE with output capacitor (OCL = 0) or SE without output capacitors (OCL = 1). **Default is OCL = 0**
8. N3D1 selects between two different 3D configurations
9. SE/Diff-SE/Diff = 0 for SE mode; SE/Diff = 1 for Diff mode

TABLE 3. Programmable National 3D Audio

	N3D3	N3D2
Low	0	0
Medium	0	1
High	1	0
Maximum	1	1

TABLE 4. Input/Output Control

	L2R2	L1R1	SE/DIFF
Select $L_{IN1}$ and $R_{IN1}$ Stereo Pair	0	1	0
Select $L_{IN2}$ and $R_{IN2}$ Stereo Pair	1	0	0
Select $L_{IN1}+L_{IN2}$ and $R_{IN1}+R_{IN2}$ Stereo Pair	1	1	0
Sets Stereo Inputs to Differential	x	x	1

X = Don't Care

TABLE 5. Output Volume Control Table

Volume Step	xVC4	xVC3	xVC2	xVC1	xVC0	Gain, dB
1	0	0	0	0	0	-59.50
2	0	0	0	0	1	-48.00
3	0	0	0	1	0	-40.50
4	0	0	0	1	1	-34.50
5	0	0	1	0	0	-30.00
6	0	0	1	0	1	-27.00
7	0	0	1	1	0	-24.00
8	0	0	1	1	1	-21.00
9	0	1	0	0	0	-18.00
10	0	1	0	0	1	-15.00
11	0	1	0	1	0	-13.50
12	0	1	0	1	1	-12.00
13	0	1	1	0	0	-10.50
14	0	1	1	0	1	-9.00
15	0	1	1	1	0	-7.50
16	0	1	1	1	1	-6.00
17	1	0	0	0	0	-4.50
18	1	0	0	0	1	-3.00
19	1	0	0	1	0	-1.50
20	1	0	0	1	1	0.00
21	1	0	1	0	0	1.50
22	1	0	1	0	1	3.00
23	1	0	1	1	0	4.50
24	1	0	1	1	1	6.00
25	1	1	0	0	0	7.50
26	1	1	0	0	1	9.00
27	1	1	0	1	0	10.50
28	1	1	0	1	1	12.00
29	1	1	1	0	0	13.50
30	1	1	1	0	1	15.00
31	1	1	1	1	0	16.50
32	1	1	1	1	1	18.00

1. x = M, L, or R

TABLE 6. Output Mode Selection

Output Mode Number	MC2	MC1	MC0	Handsfree Mono Output	Right HP Output	Left HP Output
0	0	0	0	SD	SD	SD
1	0	0	1	2 x G <sub>M</sub> x M	MUTE	MUTE
2	0	1	0	SD	G <sub>M</sub> x M	G <sub>M</sub> x M
3	0	1	1	G <sub>L</sub> x L + G <sub>R</sub> x R	MUTE	MUTE
4	1	0	0	SD	G <sub>R</sub> x R	G <sub>L</sub> x L
5	1	0	1	G <sub>L</sub> x L + G <sub>R</sub> x R + 2(G <sub>M</sub> x M)	MUTE	MUTE
6	1	1	0	SD	G <sub>R</sub> x R + G <sub>M</sub> x M	G <sub>L</sub> x L + G <sub>M</sub> x M
7	1	1	1	G <sub>R</sub> x R + G <sub>L</sub> x L	G <sub>R</sub> x R	G <sub>L</sub> x L

Note: L and R are selected by modes from Table 4.  
 On initial POWER ON, the default mode is 000  
 M = Mono  
 R = R<sub>IN</sub>  
 L = L<sub>IN</sub>  
 SD = Shutdown  
 MUTE = Mute Mode  
 G<sub>M</sub> = Mono volume control gain  
 G<sub>R</sub> = Right stereo volume control gain  
 G<sub>L</sub> = Left stereo volume control gain

**NATIONAL 3D ENHANCEMENT**

The LM4947 features a stereo headphone, 3D audio enhancement effect that widens the perceived soundstage from a stereo audio signal. The 3D audio enhancement creates a perceived spatial effect optimized for stereo headphone listening. The LM4947 can be programmed for a “narrow” or “wide” soundstage perception. The narrow soundstage has a more focused approaching sound direction, while the wide soundstage has a spatial, theater-like effect. Within each of these two modes, four discrete levels of 3D effect that can be programmed: low, medium, high, and maximum (Table 2), each level with an ever increasing aural effect, respectively. The difference between each level is 3dB.

The external capacitors, shown in Figure 6, are required to enable the 3D effect. The value of the capacitors set the cutoff frequency of the 3D effect, as shown by Equations 1 and 2. Note that the internal 20kΩ resistor is nominal (±25%).

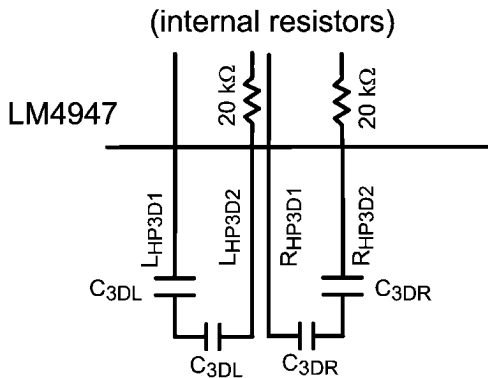

FIGURE 5. External 3D Effect Capacitors

20173509

$$f_{3DL(-3dB)} = 1 / 2\pi * 20k\Omega * C_{3DL} \quad (1)$$

$$f_{3DR(-3dB)} = 1 / 2\pi * 20k\Omega * C_{3DR} \quad (2)$$

Optional resistors R<sub>3DL</sub> and R<sub>3DR</sub> can also be added (Figure 7) to affect the -3dB frequency and 3D magnitude.

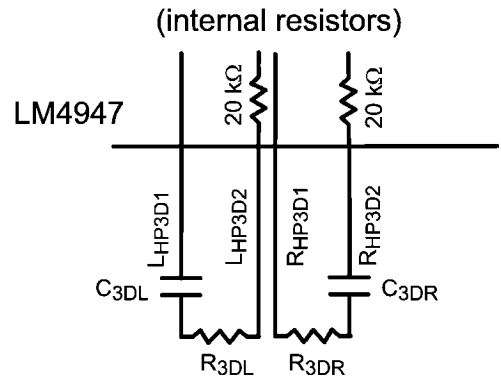

20173508

FIGURE 6. External RC Network with Optional R<sub>3DL</sub> and R<sub>3DR</sub> Resistors

$$f_{3DL(-3dB)} = 1 / 2\pi * (20k\Omega + R_{3DL}) * C_{3DL} \quad (3)$$

$$f_{3DR(-3dB)} = 1 / 2\pi * (20k\Omega + R_{3DR}) * C_{3DR} \quad (4)$$

$\Delta AV$  (change in AC gain) =  $1 / 1 + M$ , where  $M$  represents some ratio of the nominal internal resistor,  $20k\Omega$  (see example below).

$$C_{\text{Equivalent}} (\text{new}) = C_{3D} / 1 + M \quad (6)$$

$$f_{3dB} (3D) = 1 / 2\pi (1 + M)(20k\Omega * C_{3D}) \quad (5)$$

**TABLE 7. Pole Locations**

$R_{3D}$ (k $\Omega$ ) (optional)	$C_{3D}$ (nF)	M	$\Delta AV$ (dB)	f-3dB (3D) (Hz)	Value of $C_{3D}$ to keep same pole location (nF)	new Pole Location (Hz)
0	68	0	0	117		
1	68	0.05	-0.4	111	64.8	117
5	68	0.25	-1.9	94	54.4	117
10	68	0.50	-3.5	78	45.3	117
20	68	1.00	-6.0	59	34.0	117

### PCB LAYOUT AND SUPPLY REGULATION CONSIDERATIONS FOR DRIVING 8 $\Omega$ LOAD

Power dissipated by a load is a function of the voltage swing across the load and the load's impedance. As load impedance decreases, load dissipation becomes increasingly dependent on the interconnect (PCB trace and wire) resistance between the amplifier output pins and the load's connections. Residual trace resistance causes a voltage drop, which results in power dissipated in the trace and not in the load as desired. For example,  $0.1\Omega$  trace resistance reduces the output power dissipated by an  $8\Omega$  load from  $158.3mW$  to  $156.4mW$ . The problem of decreased load dissipation is exacerbated as load impedance decreases. Therefore, to maintain the highest load dissipation and widest output voltage swing, PCB traces that connect the output pins to a load must be as wide as possible.

Poor power supply regulation adversely affects maximum output power. A poorly regulated supply's output voltage decreases with increasing load current. Reduced supply voltage causes decreased headroom, output signal clipping, and reduced output power. Even with tightly regulated supplies, trace resistance creates the same effects as poor supply regulation. Therefore, making the power supply traces as wide as possible helps maintain full output voltage swing.

### POWER DISSIPATION AND EFFICIENCY

In general terms, efficiency is considered to be the ratio of useful work output divided by the total energy required to produce it with the difference being the power dissipated, typically, in the IC. The key here is "useful" work. For audio systems, the energy delivered in the audible bands is considered useful including the distortion products of the input signal. Sub-sonic (DC) and super-sonic components (> $22kHz$ ) are not useful. The difference between the power flowing from the power supply and the audio band power being transduced is dissipated in the LM4947 and in the transducer load. The amount of power dissipation in the LM4947 is very low. This is because the ON resistance of the switches used to form the output waveforms is typically less than  $0.25\Omega$ . This leaves only the transducer load as a potential "sink" for the small excess of input power over audio band output power. The LM4947 dissipates only a fraction of the excess power requiring no additional PCB area or copper plane to act as a heat sink.

The LM4947 also has a pair of single-ended amplifiers driving stereo headphones,  $R_{HP}$  and  $L_{HP}$ . The maximum internal

power dissipation for  $R_{HP}$  and  $L_{HP}$  is given by equation (9) and (10). From Equations (9) and (10), assuming a 5V power supply and a  $32\Omega$  load, the maximum power dissipation for  $L_{HP}$  and  $R_{HP}$  is  $40mW$ , or  $80mW$  total.

$$P_{\text{DMAX-LHP}} = (V_{DD})^2 / (2\pi^2 R_L): \text{Single-ended Mode} \quad (7)$$

$$P_{\text{DMAX-RHP}} = (V_{DD})^2 / (2\pi^2 R_L): \text{Single-ended Mode} \quad (8)$$

The maximum internal power dissipation of the LM4947 occurs when all 3 amplifiers pairs are simultaneously on; and is given by Equation (11).

$$P_{\text{DMAX-TOTAL}} = P_{\text{DMAX-SPKROUT}} + P_{\text{DMAX-LHP}} + P_{\text{DMAX-RHP}} \quad (9)$$

The maximum power dissipation point given by Equation (11) must not exceed the power dissipation given by Equation (12):

$$P_{\text{DMAX}} = (T_{J\text{MAX}} - T_A) / \theta_{JA} \quad (10)$$

The LM4947's  $T_{J\text{MAX}} = 150^\circ\text{C}$ . In the ITL package, the LM4947's  $\theta_{JA}$  is  $65^\circ\text{C/W}$ . At any given ambient temperature  $T_A$ , use Equation (12) to find the maximum internal power dissipation supported by the IC packaging. Rearranging Equation (12) and substituting  $P_{\text{DMAX-TOTAL}}$  for  $P_{\text{DMAX}}$  results in Equation (13). This equation gives the maximum ambient temperature that still allows maximum stereo power dissipation without violating the LM4947's maximum junction temperature.

$$T_A = T_{J\text{MAX}} - P_{\text{DMAX-TOTAL}} \theta_{JA} \quad (11)$$

For a typical application with a 5V power supply and an  $8\Omega$  load, the maximum ambient temperature that allows maximum stereo power dissipation without exceeding the maximum junction temperature is approximately  $104^\circ\text{C}$  for the ITL package.

$$T_{J\text{MAX}} = P_{\text{DMAX-TOTAL}} \theta_{JA} + T_A \quad (12)$$

Equation (14) gives the maximum junction temperature  $T_{J\text{MAX}}$ . If the result violates the LM4947's  $150^\circ\text{C}$ , reduce the maximum junction temperature by reducing the power supply

voltage or increasing the load resistance. Further allowance should be made for increased ambient temperatures.

The above examples assume that a device is a surface mount part operating around the maximum power dissipation point. Since internal power dissipation is a function of output power, higher ambient temperatures are allowed as output power or duty cycle decreases. If the result of Equation (11) is greater than that of Equation (12), then decrease the supply voltage, increase the load impedance, or reduce the ambient temperature. If these measures are insufficient, a heat sink can be added to reduce  $\theta_{JA}$ . The heat sink can be created using additional copper area around the package, with connections to the ground pin(s), supply pin and amplifier output pins. External, solder attached SMT heatsinks such as the Thermalloy 7106D can also improve power dissipation. When adding a heat sink, the  $\theta_{JA}$  is the sum of  $\theta_{JC}$ ,  $\theta_{CS}$ , and  $\theta_{SA}$ . ( $\theta_{JC}$  is the junction-to-case thermal impedance,  $\theta_{CS}$  is the case-to-sink thermal impedance, and  $\theta_{SA}$  is the sink-to-ambient thermal impedance). Refer to the Typical Performance Characteristics curves for power dissipation information at lower output power levels.

### POWER SUPPLY BYPASSING

As with any power amplifier, proper supply bypassing is critical for low noise performance and high power supply rejection. Applications that employ a 5V regulator typically use a  $1\mu\text{F}$  in parallel with a  $0.1\mu\text{F}$  filter capacitors to stabilize the regulator's output, reduce noise on the supply line, and improve the supply's transient response. However, their presence does not eliminate the need for a local  $1.1\mu\text{F}$  tantalum bypass capacitance connected between the LM4947's supply pins and ground. Keep the length of leads and traces that connect capacitors between the LM4947's power supply pin and ground as short as possible. Connecting a  $2.2\mu\text{F}$  capacitor,  $C_B$ , between the BYPASS pin and ground improves the internal bias voltage's stability and improves the amplifier's PSRR. The PSRR improvements increase as the bypass pin capacitor value increases. Too large, however, increases turn-on time and can compromise the amplifier's click and pop performance. The selection of bypass capacitor values, especially  $C_B$ , depends on desired PSRR requirements, click and pop performance (as explained in the section, Proper Selection of External Components), system cost, and size constraints.

### SELECTING EXTERNAL COMPONENTS

#### Input Capacitor Value Selection

Amplifying the lowest audio frequencies requires high value input coupling capacitor ( $C_i$  in Figures 1 & 2). A high value capacitor can be expensive and may compromise space efficiency in portable designs. In many cases, however, the speakers used in portable systems, whether internal or external, have little ability to reproduce signals below 150Hz. Applications using speakers with this limited frequency response reap little improvement by using large input capacitor.

The internal input resistor ( $R_i$ ), nominal  $20\text{k}\Omega$ , and the input capacitor ( $C_i$ ) produce a high pass filter cutoff frequency that is found using Equation (15).

$$f_c = 1 / (2\pi R_i C_i) \quad (13)$$

As an example when using a speaker with a low frequency limit of 150Hz,  $C_i$ , using Equation (15) is  $0.053\mu\text{F}$ . The  $0.22\mu\text{F}$   $C_i$  shown in *Figure 1* allows the LM4947 to drive high effi-

ciency, full range speaker whose response extends below 40Hz.

#### Bypass Capacitor Value Selection

Besides minimizing the input capacitor size, careful consideration should be paid to value of  $C_B$ , the capacitor connected to the BYPASS bump. Since  $C_B$  determines how fast the LM4947 settles to quiescent operation, its value is critical when minimizing turn-on pops. The slower the LM4947's outputs ramp to their quiescent DC voltage (nominally  $V_{DD}/2$ ), the smaller the turn-on pop. Choosing  $C_B$  equal to  $1.0\mu\text{F}$  along with a small value of  $C_i$  (in the range of  $0.1\mu\text{F}$  to  $0.39\mu\text{F}$ ), produces a click-less and pop-less shutdown function. As discussed above, choosing  $C_i$  no larger than necessary for the desired bandwidth helps minimize clicks and pops.  $C_B$ 's value should be in the range of 5 times to 7 times the value of  $C_i$ . This ensures that output transients are eliminated when power is first applied or the LM4947 resumes operation after shutdown.

DEMO BOARD SCHEMATIC

LM4947

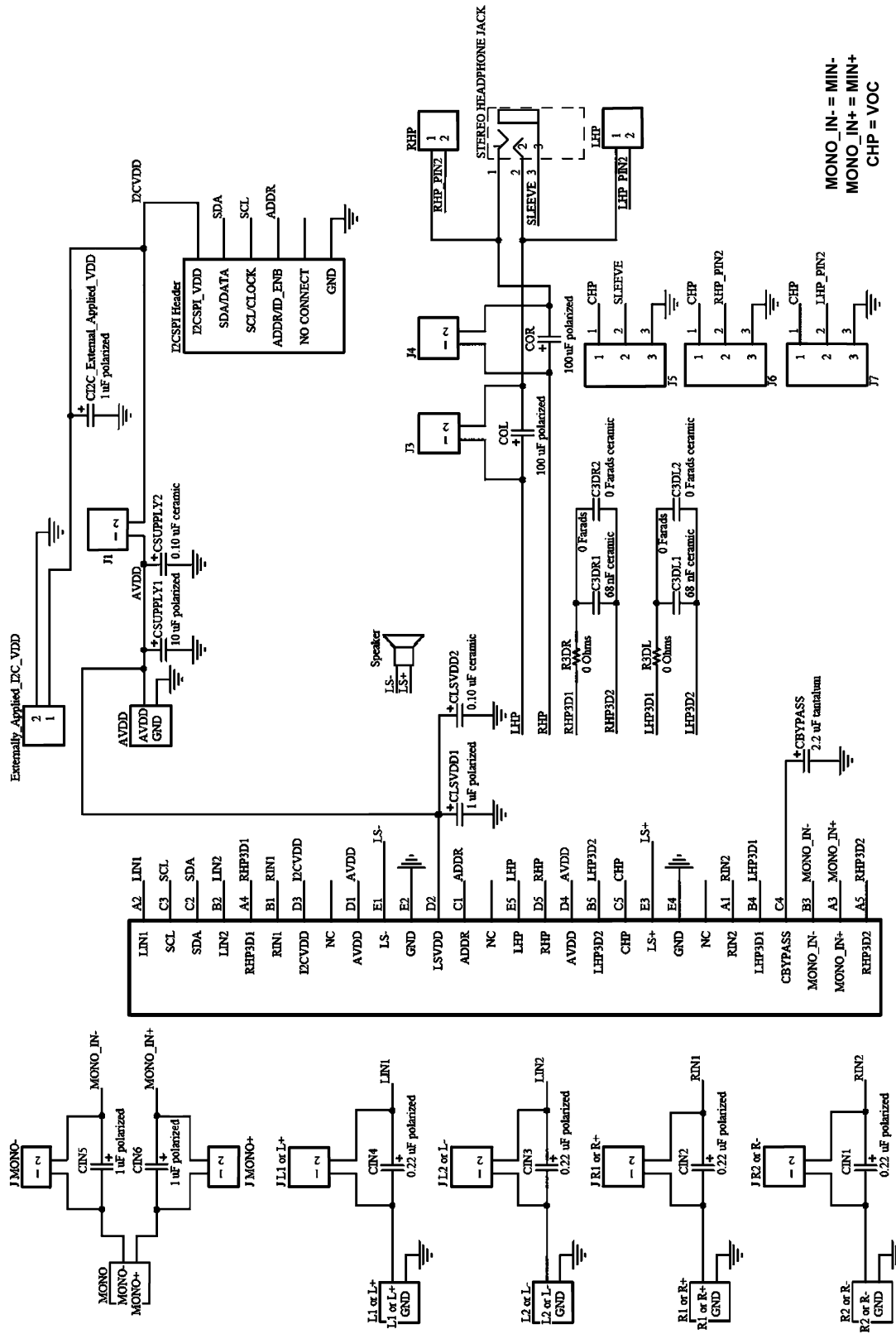

MONO\_IN- = MIN-  
 MONO\_IN+ = MIN+  
 CHP = VOC

20173510

## Revision History

Rev	Date	Description
1.0	06/16/06	Initial release.
1.1	06/19/06	Changed the Class D Efficiency (n) on Typical limit (from 79 to 86) on the 5V specification table.
1.2	06/22/06	Added more Typ Perf curves.
1.3	07/18/06	Replaced some of the curves.
1.4	08/29/06	Text edits.
1.5	10/18/06	Edited micro SMD pkg drawing, Figure 1, and Figure 2. Changed $I_{DDQ}$ typical and limit values on the 3.3V and 5.0V specification table. Removed CMRR SE condition and changed typical values for CMRR BTL on 3.3V and 5.0V specification table. Changed Mute Attenuation typical value on 5.0V specification table.
1.6	03/02/07	Edited the 3.3V and 5V EC tables.
1.7	03/02/07	Composed (CONFIDENTIAL) D/S for customer (SAMSUNG).
1.8	09/06/07	Edited Table 4.
1.9	11/09/07	Text edits.



**Physical Dimensions** inches (millimeters) unless otherwise noted

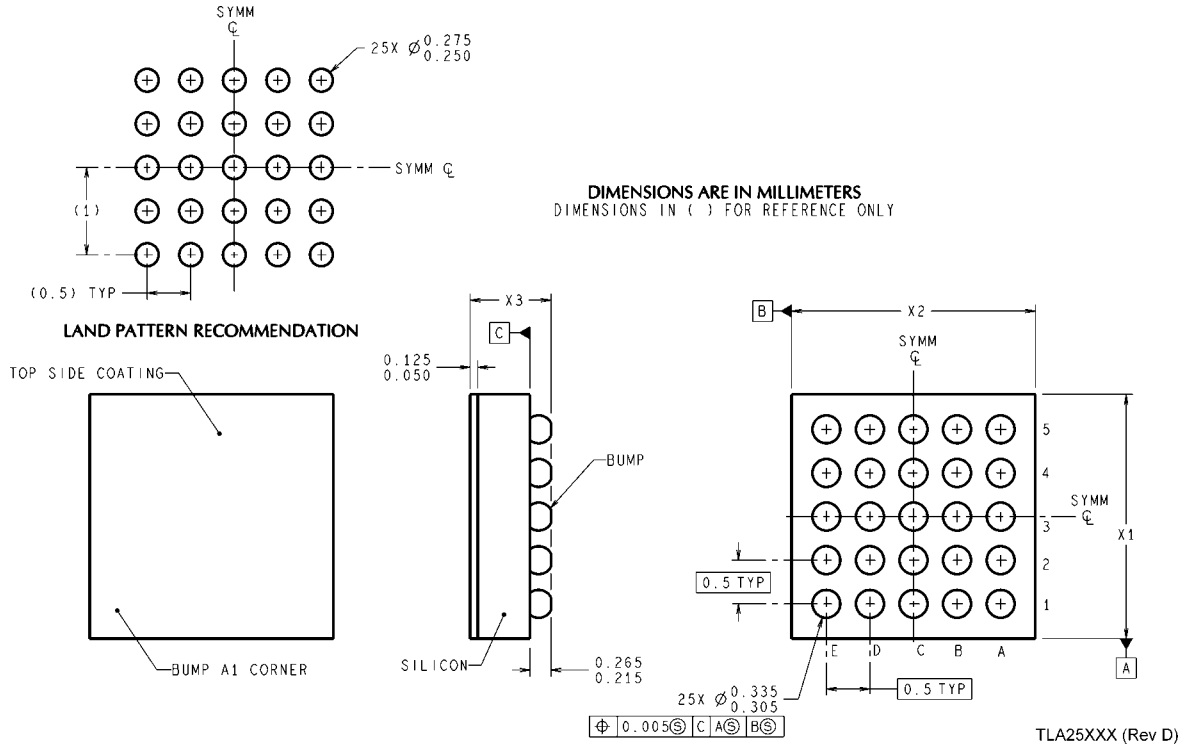

**25 – Bump micro SMD**  
**Order Number LM4947TL**  
**NS Package Number TLA25BBA**  
**Dimensions are in millimeters**  
 **$X_1 = 2.517 \pm 0.01$   $X_2 = 2.517 \pm 0.01$   $X_3 = 0.600 \pm 0.10$**

## Notes

For more National Semiconductor product information and proven design tools, visit the following Web sites at:

Products		Design Support	
Amplifiers	<a href="http://www.national.com/amplifiers">www.national.com/amplifiers</a>	WEBENCH	<a href="http://www.national.com/webench">www.national.com/webench</a>
Audio	<a href="http://www.national.com/audio">www.national.com/audio</a>	Analog University	<a href="http://www.national.com/AU">www.national.com/AU</a>
Clock Conditioners	<a href="http://www.national.com/timing">www.national.com/timing</a>	App Notes	<a href="http://www.national.com/appnotes">www.national.com/appnotes</a>
Data Converters	<a href="http://www.national.com/adc">www.national.com/adc</a>	Distributors	<a href="http://www.national.com/contacts">www.national.com/contacts</a>
Displays	<a href="http://www.national.com/displays">www.national.com/displays</a>	Green Compliance	<a href="http://www.national.com/quality/green">www.national.com/quality/green</a>
Ethernet	<a href="http://www.national.com/ethernet">www.national.com/ethernet</a>	Packaging	<a href="http://www.national.com/packaging">www.national.com/packaging</a>
Interface	<a href="http://www.national.com/interface">www.national.com/interface</a>	Quality and Reliability	<a href="http://www.national.com/quality">www.national.com/quality</a>
LVDS	<a href="http://www.national.com/lvds">www.national.com/lvds</a>	Reference Designs	<a href="http://www.national.com/refdesigns">www.national.com/refdesigns</a>
Power Management	<a href="http://www.national.com/power">www.national.com/power</a>	Feedback	<a href="http://www.national.com/feedback">www.national.com/feedback</a>
Switching Regulators	<a href="http://www.national.com/switchers">www.national.com/switchers</a>		
LDOs	<a href="http://www.national.com/ldo">www.national.com/ldo</a>		
LED Lighting	<a href="http://www.national.com/led">www.national.com/led</a>		
PowerWise	<a href="http://www.national.com/powerwise">www.national.com/powerwise</a>		
Serial Digital Interface (SDI)	<a href="http://www.national.com/sdi">www.national.com/sdi</a>		
Temperature Sensors	<a href="http://www.national.com/tempsensors">www.national.com/tempsensors</a>		
Wireless (PLL/VCO)	<a href="http://www.national.com/wireless">www.national.com/wireless</a>		

THE CONTENTS OF THIS DOCUMENT ARE PROVIDED IN CONNECTION WITH NATIONAL SEMICONDUCTOR CORPORATION ("NATIONAL") PRODUCTS. NATIONAL MAKES NO REPRESENTATIONS OR WARRANTIES WITH RESPECT TO THE ACCURACY OR COMPLETENESS OF THE CONTENTS OF THIS PUBLICATION AND RESERVES THE RIGHT TO MAKE CHANGES TO SPECIFICATIONS AND PRODUCT DESCRIPTIONS AT ANY TIME WITHOUT NOTICE. NO LICENSE, WHETHER EXPRESS, IMPLIED, ARISING BY ESTOPPEL OR OTHERWISE, TO ANY INTELLECTUAL PROPERTY RIGHTS IS GRANTED BY THIS DOCUMENT.

TESTING AND OTHER QUALITY CONTROLS ARE USED TO THE EXTENT NATIONAL DEEMS NECESSARY TO SUPPORT NATIONAL'S PRODUCT WARRANTY. EXCEPT WHERE MANDATED BY GOVERNMENT REQUIREMENTS, TESTING OF ALL PARAMETERS OF EACH PRODUCT IS NOT NECESSARILY PERFORMED. NATIONAL ASSUMES NO LIABILITY FOR APPLICATIONS ASSISTANCE OR BUYER PRODUCT DESIGN. BUYERS ARE RESPONSIBLE FOR THEIR PRODUCTS AND APPLICATIONS USING NATIONAL COMPONENTS. PRIOR TO USING OR DISTRIBUTING ANY PRODUCTS THAT INCLUDE NATIONAL COMPONENTS, BUYERS SHOULD PROVIDE ADEQUATE DESIGN, TESTING AND OPERATING SAFEGUARDS.

EXCEPT AS PROVIDED IN NATIONAL'S TERMS AND CONDITIONS OF SALE FOR SUCH PRODUCTS, NATIONAL ASSUMES NO LIABILITY WHATSOEVER, AND NATIONAL DISCLAIMS ANY EXPRESS OR IMPLIED WARRANTY RELATING TO THE SALE AND/OR USE OF NATIONAL PRODUCTS INCLUDING LIABILITY OR WARRANTIES RELATING TO FITNESS FOR A PARTICULAR PURPOSE, MERCHANTABILITY, OR INFRINGEMENT OF ANY PATENT, COPYRIGHT OR OTHER INTELLECTUAL PROPERTY RIGHT.

### LIFE SUPPORT POLICY

**NATIONAL'S PRODUCTS ARE NOT AUTHORIZED FOR USE AS CRITICAL COMPONENTS IN LIFE SUPPORT DEVICES OR SYSTEMS WITHOUT THE EXPRESS PRIOR WRITTEN APPROVAL OF THE CHIEF EXECUTIVE OFFICER AND GENERAL COUNSEL OF NATIONAL SEMICONDUCTOR CORPORATION.** As used herein:

Life support devices or systems are devices which (a) are intended for surgical implant into the body, or (b) support or sustain life and whose failure to perform when properly used in accordance with instructions for use provided in the labeling can be reasonably expected to result in a significant injury to the user. A critical component is any component in a life support device or system whose failure to perform can be reasonably expected to cause the failure of the life support device or system or to affect its safety or effectiveness.

National Semiconductor and the National Semiconductor logo are registered trademarks of National Semiconductor Corporation. All other brand or product names may be trademarks or registered trademarks of their respective holders.

Copyright© 2007 National Semiconductor Corporation

For the most current product information visit us at [www.national.com](http://www.national.com)



**National Semiconductor Americas Customer Support Center**  
 Email: [new.feedback@nsc.com](mailto:new.feedback@nsc.com)  
 Tel: 1-800-272-9959

**National Semiconductor Europe Customer Support Center**  
 Fax: +49 (0) 180-530-85-86  
 Email: [europe.support@nsc.com](mailto:europe.support@nsc.com)  
 Deutsch Tel: +49 (0) 69 9508 6208  
 English Tel: +49 (0) 870 24 0 2171  
 Français Tel: +33 (0) 1 41 91 8790

**National Semiconductor Asia Pacific Customer Support Center**  
 Email: [ap.support@nsc.com](mailto:ap.support@nsc.com)

**National Semiconductor Japan Customer Support Center**  
 Fax: 81-3-5639-7507  
 Email: [jpn.feedback@nsc.com](mailto:jpn.feedback@nsc.com)  
 Tel: 81-3-5639-7560